

ZONING COMMITTEE STAFF REPORT

1. **FILE NAME:** Ford Master Plan & Zoning Amendments **FILE #:** 20-010013 & 20-009995
 2. **APPLICANT:** Project Paul, LLC (Ryan Co.) & MN Ford Site Apartment Land, LLC (Wiedner)
 3. **TYPE OF APPLICATION:** Master Plan & Zoning Amendments **HEARING DATE:** 3/12/2020
 4. **LOCATION:** 2192 Ford Parkway et al, SE corner of Ford Parkway & Mississippi River Blvd.
 5. **PIN & LEGAL DESCRIPTION:** 17-28-23-13-002 et al; legal description see file
 6. **PLANNING DISTRICT:** 15 **EXISTING ZONING:** F1-F6
 7. **ZONING CODE REFERENCE:** § 61.801(b), § 64.502, §§ 66.900 - 66.953
 8. **STAFF REPORT DATE:** 3/5/2020 **BY:** Menaka Mohan
 9. **DATE RECEIVED:** 1/31/2020 **DEADLINE FOR ACTION:** 4/14/2020 (extended)
-

- A. **PURPOSE:** Ford site master plan and zoning amendments including district boundary adjustments to match platted streets and standards for townhouse and multi-family medium building types, supportive housing, religious institutions, minimum commercial in F6, lot coverage, signs, and the Woodlawn roadway section.
- B. **PARCEL SIZE:** 6,050,047 square feet
- C. **EXISTING LAND USE:** Vacant
- D. **SURROUNDING LAND USE:**
 - North: Primarily commercial, with residential near the northwest corner of the site
 - East: Primarily multi-family residential, with some commercial in the NE corner of the site
 - South: Unused rail yard with one-family residential and park beyond
 - West: Abandoned industrial with occasional use for parking, park, Mississippi River
- E. **STATE STATUTE & ZONING CODE CITATIONS:** MN Stat. § 462.357 provides that zoning code amendments may be initiated by petition of affected property owners as defined in the zoning ordinance. Zoning Code § 61.801(b) provides for zoning code amendments to be initiated by application of the owners of 67% of the area of the property affected by the amendments. Zoning Code §§ 66.900 – 66.953 are the Ford Districts sections of the Zoning Code. § 66.951 provides for amendments to the *Ford Site Zoning and Public Realm Master Plan* (Ford MP). § 64.502 contains specific sign regulations for residential uses and is proposed to be amended to include entirely residential uses in Ford districts.
- F. **HISTORY/DISCUSSION:**

On September 27, 2017 the City Council adopted Zoning Code § 69.900 Ford Districts and the *Ford Site Zoning and Public Realm Master Plan* (Ford MP) after a decade of community input and planning. § 69.900 created six new zoning districts specifically for the Ford Site. The Ford MP provides additional standards for specific building types, mix of uses, housing variety, jobs and tax base, energy and sustainability, transportation, parks and amenities.

In June 2018 Ford Motor Companies announced Ryan Companies (Ryan) as the Master Developer for the Ford Site. In October 2018 Ryan proposed Ford MP and zoning amendments that were adopted by the City Council in April 2019 and adopted again September 2019 to include design standards. In December 2019 Ryan purchased the Ford site.

Project Paul, LLC (Ryan) and MN Ford Site Apartment Land (Weidner), the current owners of 82% of the area of the parcels of land in the Ford zoning districts, have jointly applied to amend the *Ford Site Zoning and Public Realm Master Plan*, zoning regulations that pertain to the Ford districts, and district boundary lines within the area of the Ford districts.

G. **DISTRICT COUNCIL RECOMMENDATION:** As of the date of this report District 15 has not provided a recommendation.

H. **FINDINGS:**

1. **Proposed Townhouse Amendments:**

	Description	Code Section	Ford MP Pages	Recommendation
1a	Add townhouse to the allowable building type in F1 zoning district	66.912, 66.931	31, 34, 72, 92	Recommend
1b	Adjust townhouse minimum lot width from 30' to 20'	66.931	93, 97	Recommend with new footnote that it's a per unit figure
1c	Adjust townhouse maximum building width from 150' to 350'	66.931	93, 97	Recommend
1d	Adjust townhouse maximum lot coverage by buildings from 50% to 60%	66.931	93, 97	Lot coverage increase not needed; add note that it applies to the entire parcel, not lot under each unit
1e	Adjust townhouse minimum setback from shared bike/ped paths from 10' to 4'	66.931	93, 97	Recommend against

In 2017 and 2018 the Planning Commission expressed a desire for more density near the river. Allowing a denser building type such as townhouse in the F1 district meets that goal.

Reducing the lot width from 30' to 20', with a footnote to make it clear that this is a per unit standard that applies to the entire zoning lot on which the townhouse building is built, is consistent with the 20' per unit minimum lot width requirement for a townhouse in the RT2 townhouse residential district and for a townhouse in T1-T3 traditional neighborhood districts. The minimum lot width standards for the Ford districts in Zoning Code Table 66.931 and in the building type standards tables in the Ford MP are not otherwise written as "per unit" standards.

Expanding the maximum building width from 150' to 350' meets the intent of Ford MP Table 6.2 to allow a townhouse building with up to 16 units, which would be at least 320' wide for the smallest 20' wide townhouse units.

The residential district dimensional standards table has a footnote that townhouse lot size standards apply to the entire zoning lot on which the townhouse building is built, not to an individually described lot under an individual unit. Adding the following new footnote (b) to Zoning Code *Table 66.931 Ford District Dimensional Standards* and to Ford MP *Table 6.2 Building Type Standards Summary Table* would make it clear that floor area ratio (FAR), lot width, and lot coverage standards for townhouses similarly apply to the entire zoning lot in the Ford districts:

- (b) The minimum lot width figure for townhouses is per unit. Where land under each unit constitutes an individually described lot and all other land required for yards, parking and access constitutes "common" properties jointly owned by the owners of the units, the floor area ratio, lot width, and lot coverage requirements shall be applied to the entire parcel.

This new footnote (b) appears to make increasing the maximum lot coverage by townhouse buildings from 50% to 60% unnecessary. Existing footnote (b) of *Table 6.2 Building Type*

Standards Summary Table in the Ford MP can be combined with footnote (a). These footnotes, currently (f) and (g), can also be combined in Zoning Code *Table 66.931 Ford District Dimensional Standards*.

The minimum public right-of-way setback for a townhouse is 10 feet. The application states that this setback from bicycle and pedestrian paths identified in the plan for Beechwood, Saunders, and Yorkshire ROW results in a side yard condition where it is unclear where the right-of-way and the private property intersect. However, the Ford MP has specific design standards to delineate between public and private space. Specifications for lawns and gardens, pavements and surfaces, and walls, fences, and furnishings apply to the entire site and can be used to demark public ROW and private space.

Reducing the minimum setback to 6', for a total of 10' between the path and the building, could be done by adding the following underlined language to the combined footnotes for public right-of-way setbacks in Zoning Code *Table 66.931 Ford District Dimensional Standards* (becoming (h) with new footnotes proposed to be added to the table), and to the same combined footnotes (a) and (b) to Ford MP *Table 6.2 Building Type Standards Summary Table*.

- (h) Maximum building setback shall apply to at least sixty (60) percent of the building façade along the right-of-way. Buildings shall be setback a minimum of thirty (30) feet, with no maximum setback, from a lot line separating a lot from Mississippi River Boulevard. The minimum setback for a townhouse from a lot line along Beechwood, Saunders and Yorkshire Avenues shall be six (6) feet.

However, given the options in the Ford MP to delineate between public and private space this amendment is not recommended.

2. Proposed Affordable Housing Amendments

	Description	Code Section	Ford MP Pages	Recommendation
2a	Adjustment to allow Multi-Family Medium building types in the F2 zoning district	66.913, 66.931	75, 92	Recommend
2b	Adjustment to allow Multi-Family Medium building types in the F5 zoning district	66.916, 66.931	80, 92	Recommend
2c	Adjustment to allow Supportive Housing in the F6 zoning district	66.921	42, 84	Recommend

An affordable housing project on Block 9 in the F2 district can house more units in a multifamily medium building type with the same F2 height and FAR restrictions as a multifamily low building type because the Ford MP limits multifamily low buildings to between 6 and 40 units. Given that the massing of the building will not change (the FAR and height restrictions remain, and the use remains multifamily), this would be a minor change. This simplest way to do this would be to combine the multifamily low and multifamily medium building types into a single multifamily building type.

The Ford district use tables in both the Zoning Code and the Ford MP list both multiple-family dwelling and mixed residential & commercial use as permitted uses in the F5 business mixed district. However, while Ford MP *Table 6.1 Building Types Allowed by Zoning District* includes the mixed residential & commercial building type in the F5 district, it does not include

multifamily building types in the F5 district. As Ryan continues to refine the development plan, commercial uses are clustered in the F5 district. Allowing an affordable multifamily building along with mixed residential & commercial buildings in F5, similar to how both building types are allowed in T3 and T4 districts, will not detract from commercial components of the district. Providing for this includes adding a multifamily building type row under F5 in Zoning Code Table 66.931 Ford District Dimensional Standards as well as adding multifamily as a building type in F5 in Ford MP Table 6.1 Building Types Allowed by Zoning District.

Amendments were approved by City Council in 2019 to allow multi-family dwellings in the F6 district, expanding the use categories allowed in the F6 district. Allowing supportive housing in F6 is in-line with that, consistent with supportive housing being allowed in all other Ford districts and in all of the T districts.

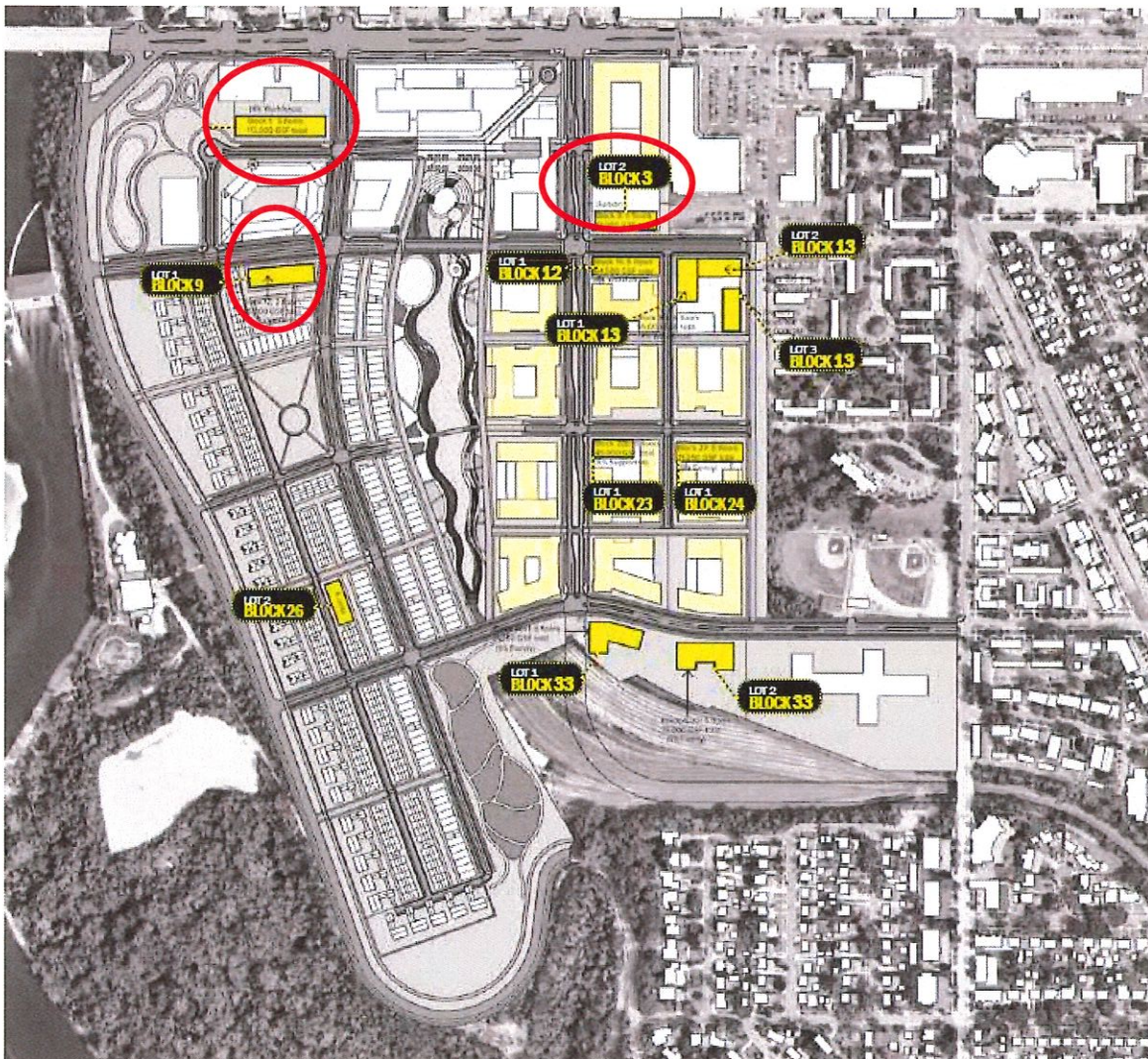

3. Proposed Land Use Amendments

	Description	Code Section	Ford MP Pages	Recommendation
3a	Adjustment to the minimum commercial in the F6 zoning district to 0%	NA	40	Recommend
3b	Adjustment to allow religious institution, place of worship in the F1 zoning district	66.921	42	Recommend

Ryan's development plan is centralizing the commercial components of the site in the F5 district. Reducing minimum commercial use to 0% in the F1 district aligns with previous City Council-approved amendments that reduced minimum commercial use to 0% in F3 and F4.

Religious institution, place of worship is currently allowed in every F district except F1. Limited commercial and institutional uses are permitted in the F1 district, including public libraries, museums, public and private parks, and playgrounds. Religious institutions and places of worship are a similar use allowed in all other residential districts, and should be permitted in the F1 district, as well.

4. Proposed Amendments to Building Type Requirements

	Description	Code Section	Ford MP Pages	Recommendation
4a	Adjust the maximum lot coverage by buildings from 70% to 95% for all applicable building types	66.931	93, 98-104	Recommend against; add underground parking exclusion instead
4b	Allow all usable rooftop space to count towards minimum open space	NA	57	Recommend

Lot coverage is defined as *the part or percent of the lot occupied by the above-grade portion of buildings*. Proposed construction of mixed use and multifamily residential buildings over underground parking that covers much of the lot to maximize land use and parking structure efficiency is consistent with Land Use Plan Policy LU-8 to ensure that zoning and infrastructure support environmentally and economically efficient land use development. Use of the top of an underground parking structure for amenity space is also consistent with this. Slopes on the Ford site result in portions of underground parking structures to be above grade and count as part of the lot coverage by buildings, making it problematic to be land-use efficient and meet the 70% lot coverage maximum. Adding the following new footnote (f) to Zoning Code *Table 66.931 Ford District Dimensional Standards*, and adding the same as a new footnote to Ford MP *Table 6.2 Building Type Standards Summary Table*, would solve this problem.

- (f) Portions of an underground parking structure that is above grade due to a slope, where the top serves as an amenity space and is less than eight (8) feet above the adjacent grade, shall be excluded from lot coverage by buildings.

The Ford MP allows usable rooftop space (*green roofs and amenity roofs*) to count toward 50% of the open space requirements of the site only if it is above the third floor. Rooftop space below the third floor can also serve as functional open space, and the "above the third-floor" limitation should be removed.

5. Proposed Roadway Amendment

	Description	Code Section	Ford MP Pages	Recommendation
5	Adjustment to the Woodlawn Ave. roadway section	NA	120	Recommend

Woodlawn was originally planned with no demarcation to separate cars, pedestrians and bicycles. Parking and a curb were added as part of a previous Ford MP amendment. Ryan has worked with City planning, public works and fire safety staff on the proposed street section amendments to address safety concerns and provide for fire truck access. Sidewalk easements along the ROW were added as part of the approved Ford plat.

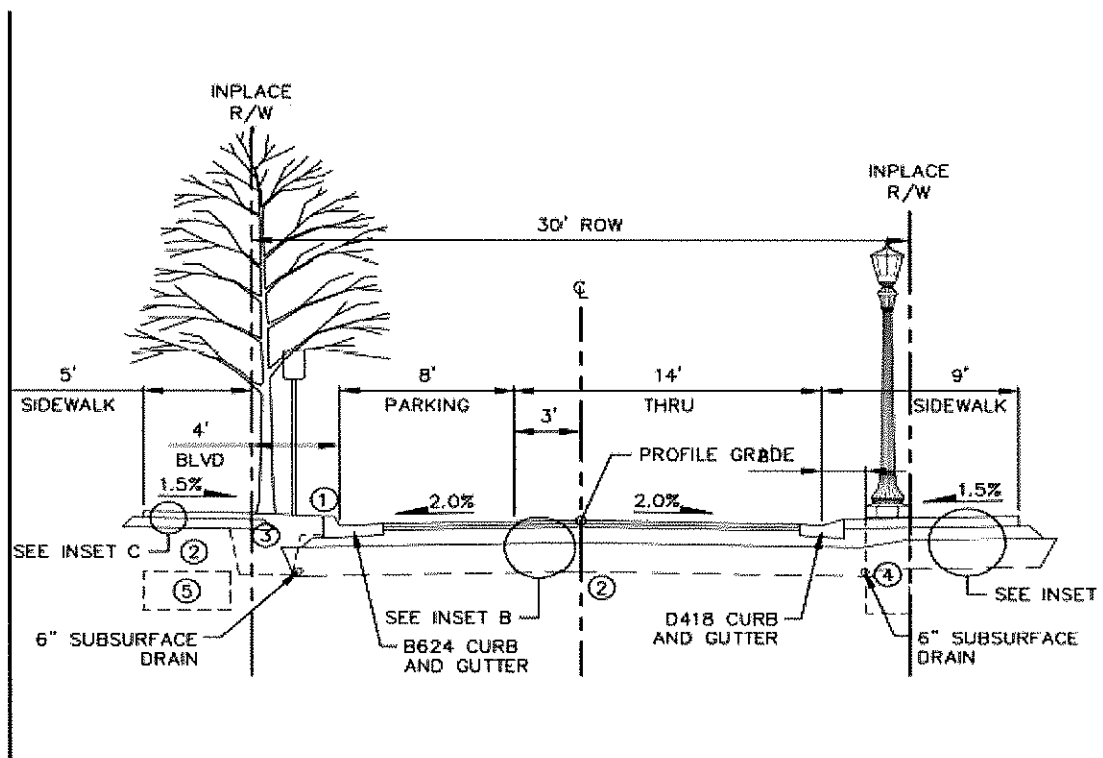

6. Proposed Signage Amendment

	Description	Code Section	Ford MP Pages	Recommendation
6	Addition of F Districts to Zoning Code § 64.502	64.502	NA	Recommend

Signs in Ford districts are currently regulated under Zoning Code § 64.503 as for T1-T4 traditional neighborhood and OS-BC business districts. Entirely residential uses in T1-T4 are regulated under § 64.502 as for RL-RM3 residential districts. This is appropriate for Ford districts as well, and can be accomplished by the following amendment.

Sec. 64.502. RL-RM3 residential and entirely residential uses in T1-T4 traditional neighborhood and F1-F6 Ford districts.

7. Proposed District Boundary Adjustments to Match Platted Streets

New streets were platted as part of the Ford site plat approved by City Council on November 20, 2019. This amendment would adjust zoning district boundaries slightly to match the center lines of platted streets in the following locations: Montreal between Finn and Mount Curve, Saunders between Cretin and Finn, and Finn north of Saunders.

- I. **STAFF RECOMMENDATION:** Based on the findings above, and with the exceptions and changes noted in the findings above, staff recommends approval of the attached Ford site master plan and zoning amendments including district boundary adjustments to match platted streets and standards for townhouse and multi-family medium building types, supportive housing, religious institutions, minimum commercial in F6, lot coverage, signs, and the Woodlawn roadway section.

EXHIBITS

Exhibit A: Summary of Ford Master Plan and Zoning Amendments

Exhibit B: Proposed Amendments to Zoning Text

Exhibit C: Proposed Amendments to the *Ford Site Zoning and Public Realm Master Plan*

Exhibit D: Ryan Companies Application

Exhibit A-Summary of Ford Master Plan and Zoning Text Amendments

	Description	Code Section	Ford MP Pages	Staff Recommendation
1a	Addition of Townhome to the Allowable Building Type in the F1 Zoning district	66.912, 66.931	31, 34, 72, 92	Recommend
1b	Adjust Townhome minimum lot width from 30' to 20'	66.931	93, 97	Recommend with new footnote that it's a per unit figure
1c	Adjust Townhouse maximum building width from 150' to 350'	66.931	93, 97	Recommend
1d	Adjust Townhouse Maximum lot coverage by building from 50% to 60%	66.931	93, 97	Lot coverage increase not needed; add note that it applies to the entire parcel, not lot under each unit
1e	Adjustments to the Townhouse minimum setbacks, for properties only adjacent to the shared bike/ped paths, from 10' to 4'	66.931	93, 97	Recommend against
2a	Adjustment to allow Multi-Family Medium building types in the F2 zoning district	66.913, 66.931	75, 92	Recommend-eliminating Multi-Family Medium Low and Medium with Multi-family
2b	Adjustment to allow Multi-Family Medium building types in the F5 zoning district	66.916, 66.931	80, 92, 98, 99	Recommend- eliminating Multi-Family Medium Low and Medium with Multi-family
2c	Adjustment to allow Supportive Housing in the F6 zoning district	66.921	42	Recommend
3a	Adjustment to the minimum commercial in the F6 zoning district to 0%	NA	40	Recommend
3b	Adjustment to allow Religious Institution, Place of Worship in the F1 zoning	66.921	42	Recommend

	district.			
4a	Adjustment to the Maximum Lot Coverage by Buildings allowed from 70% to 95% for all applicable building types listed in Table 6.2	66.931	93	Recommend against; add underground parking exclusion instead
4b	Adjustment to allow all usable rooftop space to count towards the Minimum Lot Coverage for Open Space.	NA	57	Recommend
5	Adjustment to the Woodlawn Ave roadway section.	NA	120	Recommend
6	Addition of F Districts to Section 64.502 of the Zoning Code	64.502	NA	Recommend
7	Adjust Lot District Boundary Adjustments to Match Platted Streets	60	NA	Recommend

Existing language to be deleted shown by ~~strikeout~~. New language to be added shown by underlining.

Chapter 64. Zoning Code – Signs

ARTICLE V. 64.500. SPECIFIC REGULATIONS BY ZONING DISTRICTS

Sec. 64.502. RL-RM3 residential and entirely residential uses in T1-T4 traditional neighborhood and F1-F6 Ford districts.

Chapter 66. Zoning Code – Zoning District Uses, Density and Dimensional Standards

ARTICLE IX. 66.900. FORD DISTRICTS

Division 1. 66.910. Ford District Intent

Sec. 66.912. Intent, F1 river residential district.

The F1 river residential district provides for high quality one-family, two-family, townhouse, and multi-family dwellings with up to six (6) dwelling units each and rear carriage house dwellings with an additional one (1) to two (2) dwelling units in a combined garage structure. The district is characterized by deep setbacks from Mississippi River Boulevard, consistent with the historic form along the parkway.

Sec. 66.916. Intent, F5 business mixed district.

The F5 business mixed district provides for a variety of multi-family residential, retail, dining, office and service establishments, with buildings oriented to public right-of-way, and ground floor activity that transitions between outdoor public spaces and indoor uses. Multi-family residential use may be incorporated on upper floors.

Division 2. 66.920. Ford District Uses

Sec. 66.921. Ford district use table.

Table 66.921, Ford district uses, lists all permitted and conditional uses in the F1-F6 Ford districts, and notes applicable development standards and conditions.

Table 66.921. Ford District Uses

Use	F1	F2	F3	F4	F5	F6	Definition (d) Standards (s)
Residential Uses							
<i>Dwellings</i>							
One-family dwelling	P						(d)
Two-family dwelling	P						(d)
Multiple-family dwelling	P	P	P	P	P	P	(d)
Carriage house dwelling	P	P					(d)
<i>Mixed Commercial-Residential Uses</i>							
Home occupation	P	P	P	P	P	P	(d), (s)
Live-work unit		P	P	P	P	P	(d), (s)
Mixed residential and commercial use		P	P	P	P	P	
<i>Congregate Living</i>							

EXHIBIT B: Proposed Amendments to Zoning Code Text

Use	F1	F2	F3	F4	F5	F6	Definition (d) Standards (s)
Adult care home		P	P	P	P	P	(d)
Community residential facility, licensed correctional		C	C	C			(d), (s)
Dormitory				P	P		(d), (s)
Emergency housing facility		C	C	C			(d), (s)
Foster home	P	P	P	P			(d)
Shareable housing		P	P	P	P		(d)
Shelter for battered persons	P/C	P/C	P/C	P/C	P/C		(d), (s)
Sober house	P/C	P/C	P/C	P/C	P/C		(d), (s)
Supportive housing facility	P/C	P	P	P	P	P	(d), (s)
Civic and Institutional Uses							
Club, fraternal organization, lodge hall		P	P	P	P		(d)
College, university, specialty school		P	P	P	P	P	(d), (s)
Day care, primary and secondary school		P	P	P	P	P	(d), (s)
Public library, museum	P	P	P	P	P	P	
Public and private park, playground	P	P	P	P	P	P	
Recreation, noncommercial		P	P	P	P	P	(d)
Religious institution, place of worship	P	P	P	P	P	P	(d)
Public Services and Utilities							
Antenna, cellular telephone	P/C	P/C	P/C	P/C	P/C	P/C	(d), (s)
Electric transformer or gas regulator substation			P	P	P	P	(s)
Municipal building or use	P	P	P	P	P	P	(s)
Public utility heating or cooling plant		P	P	P	P	P	
Utility or public service building	P	P	P	P	P	P	(d), (s)
Commercial Uses							
<i>Office, Retail and Service Uses</i>							
General office, studio		P	P	P	P	P	(d)
General retail		P	P	P	P	P	(d)
Service business, general		P	P	P	P	P	(d)
Service business with showroom or workshop		P	P	P	P	P	(d)
Animal day care					P	P	(d), (s)
Business sales and services					P	P	(d)
Dry cleaning, commercial laundry			P	P	P		
Farmers market		P/C	P/C	P/C	P/C	P/C	(d), (s)
Garden center, outdoor			P	P	P	P	(d)
Greenhouse				P	P	P	(d), (s)
Hospital				P	P	P	(d)
Mortuary, funeral home				P	P	P	
Outdoor commercial use			P/C	P/C	P/C	P/C	(d), (s)
Package delivery service					P	P	(d)
Small engine repair, automotive bench work					P	P	
Veterinary clinic		P	P	P	P	P	(d), (s)
<i>Food and Beverages</i>							
Bar				P/C	P/C	P/C	(d), (s)

EXHIBIT B: Proposed Amendments to Zoning Code Text

Use	F1	F2	F3	F4	F5	F6	Definition (d) Standards (s)
Brew on premises store			P	P	P	P	(d), (s)
Coffee shop, tea house		P	P	P	P	P	(d)
Restaurant		P	P	P	P	P	(d), (s)
Restaurant, fast-food					P/C	P/C	(d), (s)
<i>Commercial Recreation, Entertainment and Lodging</i>							
Bed and breakfast residence	P						(d), (s)
Health/sports club			P	P	P	P	(d)
Hotel, inn			P	P	P	P	
Indoor recreation			C	C	C	C	(d), (s)
Reception hall/rental hall			C	C	P	P	
Short-term rental dwelling unit	P/C	P/C	P/C	P/C	P/C	P/C	(d), (s)
Theater, assembly hall, concert hall			C	C	C	C	
<i>Automobile Services</i>							
Auto convenience market					C		(d), (s)
Auto service station, auto specialty store					C		(d), (s)
Auto repair station					C		(d), (s)
Auto sales, indoor					C		
Car wash, detailing					C		(s)
<i>Parking Facilities</i>							
Parking facility, commercial		C	C	C	C	C	(d)
<i>Transportation</i>							
Bus or rail passenger station				C	C	C	
Railroad right-of-way	C	C	C	C	P	P	(s)
<i>Limited Production, Processing and Storage</i>							
Agriculture	P	P	P	P	P	P	(d), (s)
Brewery, craft		P	P	P	P	P	(d)
Distillery, craft			P	P	P	P	(d)
Finishing shop					P	P	(d), (s)
Limited production and processing			P	P	P	P	(d), (s)
Mail order house			P	P	P	P	
Printing and publishing			P	P	P	P	
Recycling drop-off station					C	C	(d), (s)
Research, development and testing laboratory					P	P	
Wholesale establishment					P		(d)
Winery, craft		P	P	P	P	P	(d)
<i>Accessory Uses</i>							
Accessory use	P	P	P	P	P	P	(d), (s)
Dwelling unit, accessory	P						(d), (s)

P – Permitted use C – Conditional use requiring a conditional use permit

Notes to table 66.921, Ford district uses:

- (d) Definition for the use in Chapter 65, Land Use Definitions and Development Standards.
- (s) Standards and conditions for the use in Chapter 65, Land Use Definitions and Development Standards.

EXHIBIT B: Proposed Amendments to Zoning Code Text

Division 3. 66.930. Ford District Dimensional Standards

Sec. 66.931. Ford district dimensional standards table.

Table 66.931, Ford district dimensional standards, sets forth density and dimensional standards that are specific to Ford districts. These standards are in addition to the provisions of chapter 63, regulations of general applicability. Where an existing building does not conform to the following requirements, the building may be expanded without fully meeting the requirements as long as the expansion does not increase the nonconformity.

Table 66.931. Ford District Dimensional Standards

Building Type by Zoning District (a)	Floor Area Ratio (Min.- Max.)	Lot Width Min. (feet)	Building Width Max. (feet)	Building Height (feet)		Lot Coverage Max. by Buildings (f)	Building Setback (feet) (e)(g)	
				Min.	Max.		ROW (f)(h) (Min.- Max.)	Interior Min.
F1 river residential								
One-family dwelling	0.25 - 1.5	60	60	20	48	40%	10 - 40 (g)	10
Multi-unit home	0.25 - 1.5	80	60	20	48	40%	10 - 40 (g)	10
Townhouse, rowhouse	0.25 - 1.5 (b)	20 (b)	150	20	48	50% (b)	10 - 20	6 (i)
Carriage house	0.25 - 1.5	n/a	60	n/a	30	40%	10 - 20 (g)	6 (h)(i)
F2 residential mixed low								
Townhouse, rowhouse	1.0 - 2.0	30 20 (b)	150 350	30	55	50% (b)	10 - 20	6 (h)(i)
Multifamily-low	1.0 - 2.0	60 n/a	200 n/a	30	55	70%	10 - 20	6 (h)(i)
Carriage house	1.0 - 2.0	n/a	60	n/a	30	per main building	10 - 20	6 (h)(i)
Live/work	1.0 - 2.0	30	150	30	55	70%	5 - 20	6 (h)(i)
Nonresidential or mixed	1.0 - 2.0	n/a	500	30	55	70%	5 - 15	6 (h)(i)
F3 residential mixed mid								
Townhouse, rowhouse	1.0 - 4.0	30 20 (b)	150 350	30	65 (b) (c)	50% (b)	10 - 20	6 (h)(i)
Multifamily	2.0 - 4.0	60 n/a	n/a	40	65 (b) (c)	70%	10 - 20	6 (h)(i)
Live/work	2.0 - 4.0	30	150	40	65 (b) (c)	70%	5 - 20	6 (h)(i)
Nonresidential or mixed	2.0 - 4.0	n/a	500	40	65 (b) (c)	70%	5 - 15	6 (h)(i)
F4 residential mixed high								
Townhouse, rowhouse	3.0 - 6.0	30 20 (b)	150 350	48	75 (e) (d)	50% (b)	10 - 20	6 (h)(i)
Multifamily medium	3.0 - 6.0	n/a	n/a	48	75 (e) (d)	70%	10 - 20	6 (h)(i)
Live/work	3.0 - 6.0	30	150	48	75 (e) (d)	70%	5 - 20	6 (h)(i)
Nonresidential or mixed	3.0 - 6.0	n/a	500	48	75 (e) (d)	70%	5 - 15	6 (h)(i)
F5 business mixed								
Multifamily	2.0 - 4.0	n/a	n/a	40	65 (e)	70%	5 - 15	6 (h)(i)
Nonresidential or mixed	2.0 - 4.0	n/a	500	40	65 (e) (e)	70%	5 - 15	6 (h)(i)
F6 gateway								
Nonresidential or mixed	1.0 - 3.0	n/a	500	30	65	70%	5 - 15	6 (h)(i)

Min. - Minimum Max. - Maximum ROW - Public Right-of-Way n/a - not applicable

EXHIBIT B: Proposed Amendments to Zoning Code Text

Notes to table 66.931, Ford district dimensional standards:

- (a) Building types are described and defined in Chapter 6 of the Ford Site Zoning and Public Realm Master Plan.
- (b) The minimum lot width figure for townhouses is per unit. Where land under each unit constitutes an individually described lot and all other land required for yards, parking and access constitutes "common" properties jointly owned by the owners of the units, the floor area ratio, lot width, and lot coverage requirements shall be applied to the entire parcel.
- (c)(b) A maximum building height of seventy-five (75) feet may be permitted with a minimum ten (10) foot setback from all minimum setback lines for all portions of the building above a height of twenty-five (25) feet.
- (d)(e) All portions of a building above a height of twenty-five (25) feet shall be stepped back a minimum of ten (10) feet from all minimum setback lines. The maximum building height may exceed seventy-five (75) feet, to a maximum of one hundred ten (110) feet, subject to the following conditions:
- (1) A minimum of one (1) acre of buildable land in the F1, F2, F3, and/or F4 districts shall have been dedicated or conveyed to the city for public use for parks, playgrounds, recreation facilities, trails, or open space, in excess of the amount of land required to be dedicated for parkland at the time of platting. Such dedication of the additional parkland must be consistent with the criteria for parkland dedication in section 69.511, and is subject to city council approval.
 - (2) Maximum developable gross floor area of dedicated land from (c)(1), based on its underlying zoning, may be transferred and added to development allowed in an F4-zoned area, in compliance with other applicable requirements for the district or building, such as FAR, setbacks and open space coverage.
- (e)(d) Building height may exceed sixty-five (65) feet, to a maximum of seventy-five (75) feet, with a minimum ten (10) foot setback from all minimum setback lines for all portions of the building above a height of thirty (30) feet, except for corner elements and portions of the building facing the civic square identified in the Ford Site Zoning and Public Realm Master Plan, Chapter 8.
- (f) Portions of an underground parking structure that is above grade due to a slope, where the top serves as an amenity space and is less than eight (8) feet above the adjacent grade, shall be excluded from lot coverage by buildings.
- (g)(e) Building setback is the horizontal distance between a lot line and the nearest above-grade point of a building. An interior setback is measured from an interior lot line, which is a lot line separating a lot from another lot or lots. A public right-of-way (ROW) setback is measured from a lot line that is not an interior lot line: a lot line separating a lot from a street, alley, or public way.
- (h)(f) Maximum building setback shall apply to at least sixty (60) percent of the building facade along the right-of-way. (g) Buildings shall be setback a minimum of thirty (30) feet, with no maximum setback, from a lot line separating a lot from Mississippi River Boulevard.
- (i)(h) No setback is required for building walls containing no windows or other openings when the wall meets the fire resistance standards of the Minnesota State Building Code and there is a Common Interest Community (CIC) or recorded maintenance easement that covers the affected properties.

4.4 Zoning Districts

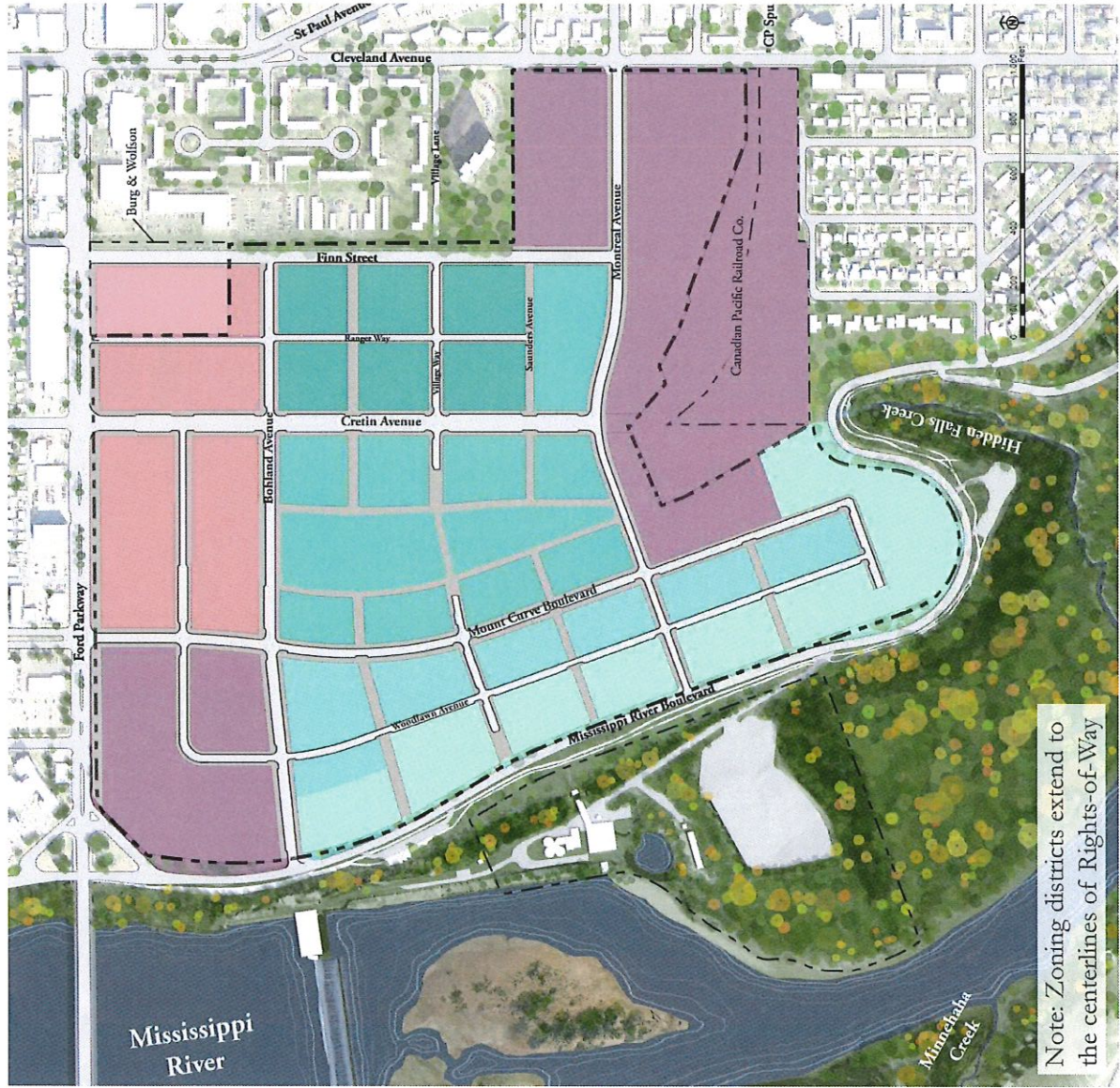

Note: Zoning districts extend to the centerlines of Rights-of-Way

The range of land use and development across the districts aims to achieve four overarching goals for the site:

- (a) A mix of uses, including residential, commercial, civic and open space uses in close proximity to one another;
- (b) A mix of housing styles, types and sizes to accommodate households of varying sizes, ages and incomes;
- (c) A system of interconnected streets and paths that offer multiple routes for motorists, pedestrians and bicyclists, and are connected to existing and future streets;
- (d) A system of open space resources and amenities; and incorporation of environmental features into the design of the neighborhood.

ZONING DISTRICTS

- River Residential (48' Max)
- Residential Mixed Low (55' Max)
- Residential Mixed Mid (65' or 75' Max)¹
- Residential Mixed High (75' or 110' Max)²
- Business Mixed (65' Max)³
- Gateway (65' Max)

¹ Maximum height up to 75' with setbacks per Table 66.931(f)(c)
² Maximum height up to 110' with dedicated parkland per Table 66.931(f)(d)
³ Maximum height up to 75' per Table 66.931(f)(c)

The site shall be developed in a moderately dense, urban manner that reflects the historic pattern of mixed-use urban neighborhoods. Buildings are to be located toward the front of the lot, ranging in height from two (2) to ten (10) stories, and occupying much of the available lot area, with remaining space used efficiently for landscaping, small yard or common areas, parking access, and storage or waste facilities.

Table 4.1 Zoning District Summary

Zoning District	Description	Land Uses	Building Heights	Floor Area Ratio
F1 River Residential	High quality design and residential form that is compatible with the look of Mississippi River Blvd Boulevard	Residential mix of one-family dwellings, multi-unit homes, townhouses , and carriage houses	20 feet - Minimum 48 feet - Maximum	0.25 - 1.5
F2 Residential Mixed Low	Primarily residential with few business uses; lower density	Residential mix of primarily townhouses with some small multi-family	30 feet - Minimum 55 feet - Maximum	1.0 - 2.0
F3 Residential Mixed Mid	Primarily residential with some business uses; medium density	Predominantly multi-family residential, with limited retail, service and office	30 feet - Minimum 65 feet - Maximum (or 75 feet with setback) ¹	1.0 - 4.0
F4 Residential Mixed High	Mix of residential and business uses; high density	Predominantly multi-family residential, with limited retail, service and office	48 feet - Minimum 75 feet - Maximum (or 110 feet with dedicated parkland) ²	3.0 - 6.0
F5 Business Mixed	Primarily retail, office and service with some multi-family residential	Primarily retail, service & office with some multi-family	40 feet - Minimum 65 feet - Maximum (or 75 feet with setback) ³	2.0 - 4.0
F6 Gateway	Attractive gateways into site, focused on employment but with some retail, service, and residential	Office, institutional, retail & service; limited multi-family, and mixed residential & commercial	30 feet - Minimum 65 feet - Maximum	1.0 - 3.0

¹ Maximum height up to 75' with setbacks per Table 66.931, note (b)(c)

² Maximum height up to 110' with dedicated parkland per Table 66.931, note (d)

³ Maximum height up to 75' per Table 66.931, note (f)(c)



F1 River Residential District

The River Residential District is intended to provide for high-quality, large home buildings with one to six dwelling units each and rear carriage units with an additional one to two housing units in a combined garage structure. The district is characterized by deep setbacks from Mississippi River Boulevard, consistent with the historic form of residential homes along the corridor.

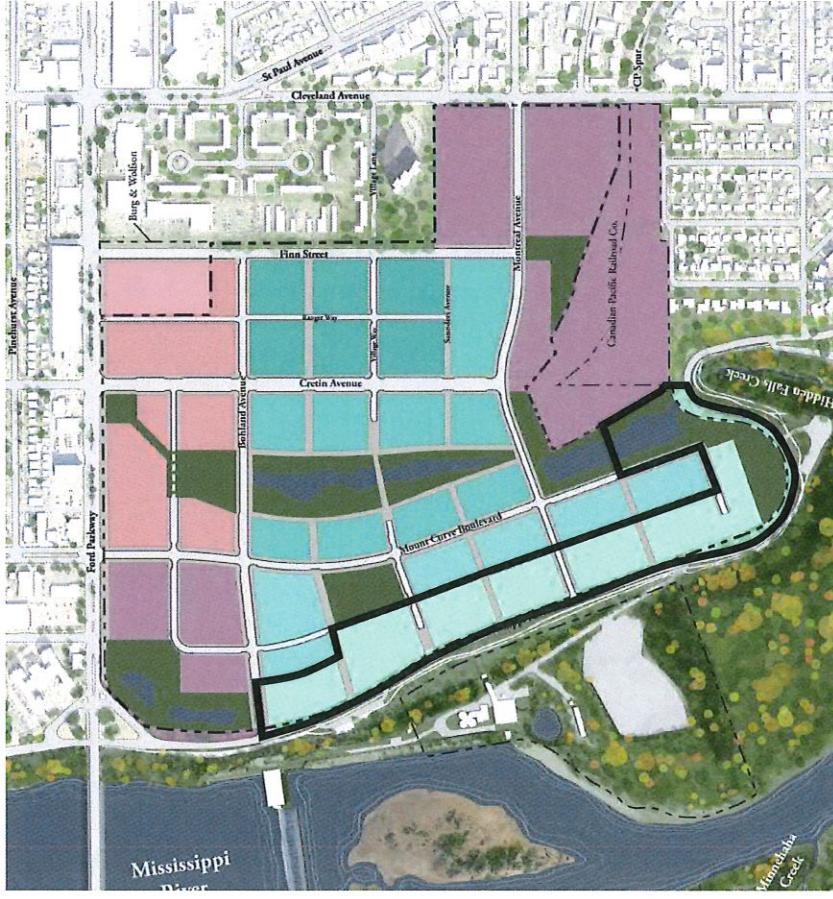

General Character	High quality design and residential form that extends the parkway-like feel and setbacks of Mississippi River Boulevard
Land Uses	Residential mix of single-family homes, townhouses , multi-unit homes, and carriage houses
Heights	
Minimum	20 feet
Maximum	48 feet
FAR	0.25 - 1.5



F3 Residential Mixed Mid District

The Residential Mixed Mid District is intended to provide for a more extensive range of multi-family residential types and a variety of congregate living arrangements, as well as transit-oriented mixed-use development with retail, office, civic and institutional uses. Variety of housing and land uses within each block is encouraged to provide visual interest and convenient pedestrian access to amenities and services.

General Character	Primarily residential with some business uses; medium density
Land Uses	Predominantly residential; some retail, service and employment
Heights	
Minimum	30 feet
Maximum	65 feet, up to 75 feet with stepbacks per Saint Paul Zoning Code Table 66.931, note (b)(c)
FAR	1.0 - 4.0

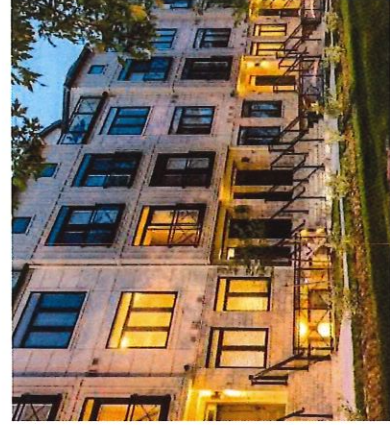

F4 Residential Mixed High District

The Residential Mixed High District provides for high-density, transit-supportive, pedestrian-friendly multi-family residential and congregate living arrangements with integrated retail, office, civic and institutional uses. The scale and mass of buildings shall be moderated with the use of vegetative buffers, step backs on upper floors, courtyards, and architectural features that add variety to the appearance of the facades.

General Character	Mix of residential and business uses, high density
Land Uses	Predominantly residential; some retail, service and employment
Heights	
Minimum	48 feet
Maximum	75 feet, up to 110 feet with dedicated parkland per Saint Paul Zoning Code Table 66.931, note (c)(d)
FAR	3.0 - 6.0

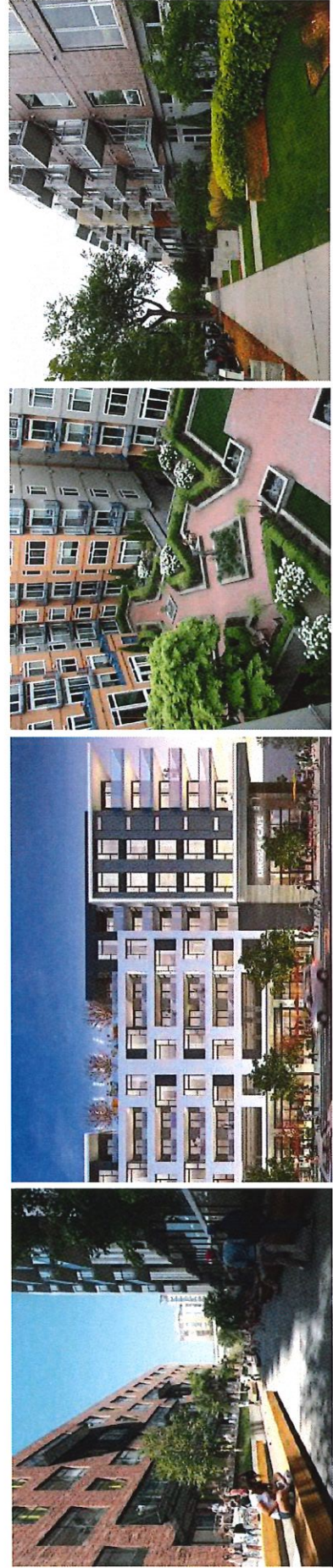

F5 Business Mixed District

The Business Mixed District provides for a variety of retail stores, dining, office buildings and service establishments. Buildings will orient to public right-of-ways and provide dynamic, ground floor activity that transitions between the outdoor public spaces and the building uses. Exterior edges will provide attractive vegetation, patios, amenities and public art that enlivens the public realm. Multi-family dwellings may be incorporated on upper floors.

General Character	Primarily retail, office and service with some multi-family residential
Land Uses	Retail, service & employment; some multi-family
Heights	
Minimum	40 feet
Maximum	65 feet, up to 75 feet per Saint Paul Zoning Code Table 66.931, note (c)
FAR	2.0 - 4.0

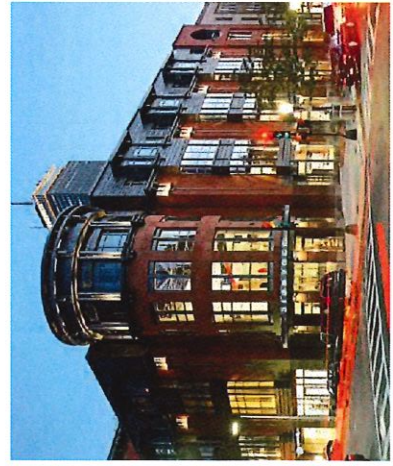
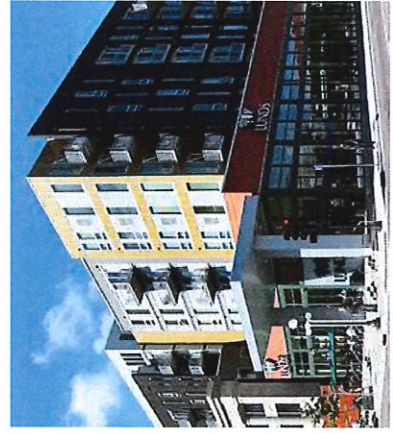
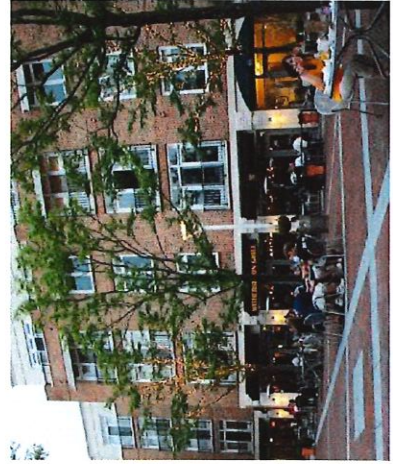

4.5 Required Mix of Uses

There is a difference between allowing a mix of uses within a district and requiring a mix. Requiring a minimum and maximum mix of uses ensures visual, functional, and economic diversity within proximity. Each district on the Ford site shall include a mix of uses as identified below. The required range of land uses by type may range from no requirement, to a base minimum, and up to a maximum percentage of floor area constructed within the entire zoning district, including all current and planned construction for that district. The requirements should be used by the site master developer throughout site build-out, to guide the selection of sub-developers and projects for each block.

Table 4.2 Required Mix of Uses

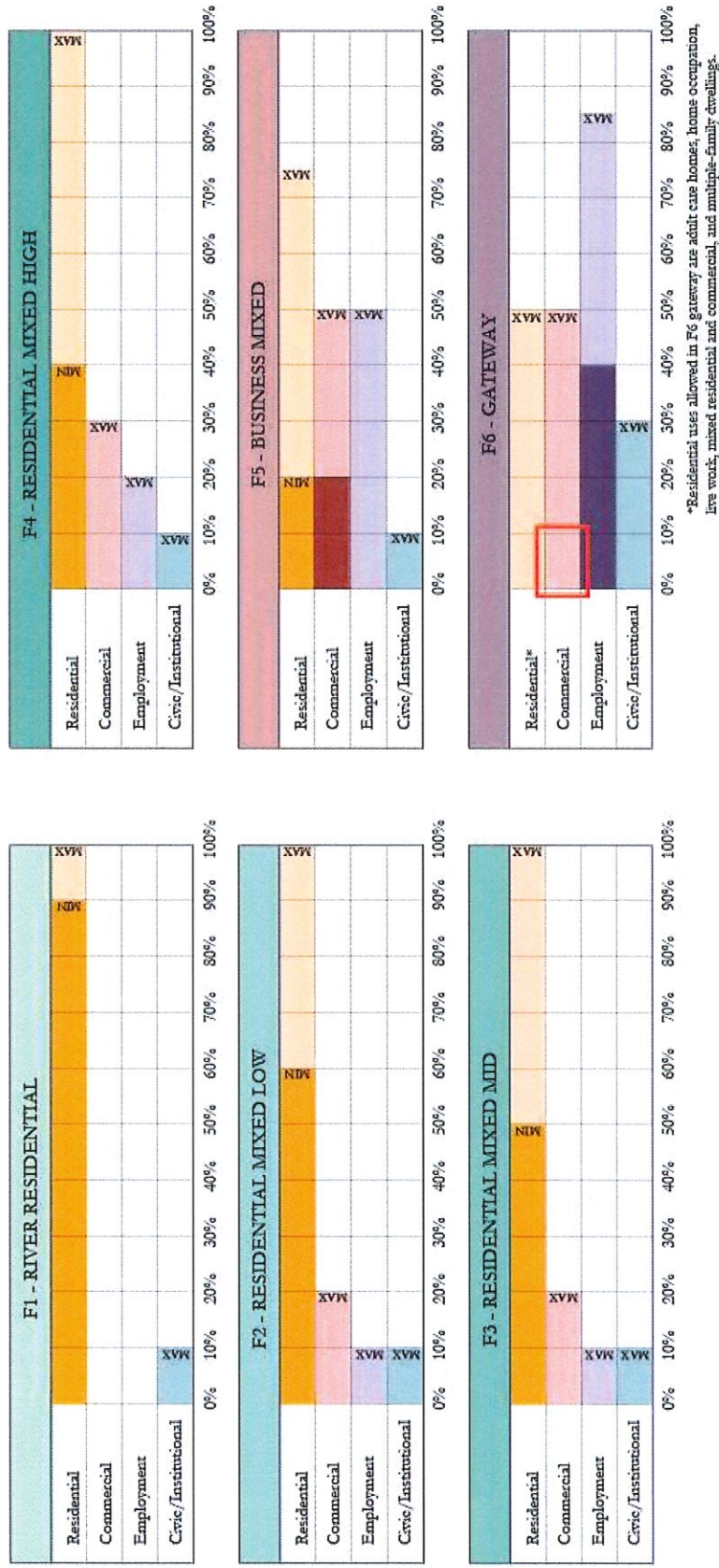

4.6 District Uses

Use	F1	F2	F3	F4	F5	F6	Definition (d) Standards (s)
Residential Uses							
<i>Dwellings</i>							
One-family dwelling	P						
Two-family dwelling	P						(d)
Multiple-family dwelling	P	P	P	P	P	P	(d)
Carriage house dwelling	P	P					(d)
<i>Mixed Commercial-Residential Uses</i>							
Home occupation	P	P	P	P	P	P	(d), (s)
Live-work unit		P	P	P	P	P	(d), (s)
Mixed residential and commercial use		P	P	P	P	P	
<i>Congregate Living</i>							
Adult care home		P	P	P	P	P	(d)
Community residential facility, licensed correctional		C	C	C			(d), (s)
Dormitory				P	P		(d), (s)
Emergency housing facility		C	C	C			(d), (s)
Foster home	P	P	P	P			(d)
Shareable housing		P	P	P	P		(d)
Shelter for battered persons	P/C	P/C	P/C	P/C	P/C	P/C	(d), (s)
Sober house	P/C	P/C	P/C	P/C	P/C	P/C	(d), (s)
Supportive housing facility	P/C	P	P	P	P	P	(d), (s)
Civic and Institutional Uses							
Club, fraternal organization, lodge hall		P	P	P	P		(d)
College, university, specialty school		P	P	P	P	P	(d), (s)
Day care, primary and secondary school		P	P	P	P	P	(d), (s)
Public library, museum	P	P	P	P	P	P	
Public and private park, playground	P	P	P	P	P	P	
Recreation, noncommercial		P	P	P	P	P	(d)
Religious institution, place of worship	P	P	P	P	P	P	(d)

Uses allowed in the Ford site Zoning Districts are identified in this table. Most of the uses identified are in the citywide zoning code, Chapter 65 Land Use Definitions and Standards.



Green Roofs

Functional Green Roof Area shall be defined as area atop a roof surface on a building, open to the sky and air, which is surfaced with soil and living plant materials for the purpose of retaining rainwater and absorbing heat from sunlight. The depth of soil and planted material shall be at least two (2) inches to be considered Functional Green Roof Area.

Roof Design Exemptions for Functional Green Roof Area

Functional Green Roof Areas shall be exempt from the rooftop design standards identified in “Pitch, Orientation, Materials and Reflectivity”.

Green Roof Areas as Open Space

Where a rooftop surface **above the third floor** includes Functional Green Roof Area, adjacent open-air outdoor space intended for use by building occupants or other persons that does not meet the definition of Functional Green Roof Area, such as a patio or deck, is eligible to meet up to 50% of the open space requirements of the property/site, as measured in gross square feet of the usable adjacent space. All such usable outdoor space shall be set back at least one (1) foot from all outer roof edges, and shall be located and oriented in relation to adjacent properties to minimize potential visual, noise and privacy impacts to abutting uses.

F1 River Residential

This district includes deep building setbacks from Mississippi River Boulevard and informal landscape consistent with the predominantly detached, single family residential character of the corridor.

Building types allowed by zoning: single family, **townhouse**, multi-unit home and carriage house.

Private Landscape Standards

S1. Trees within thirty feet (30') of Mississippi River Boulevard right-of-way shall be native species and planted in an informal pattern.

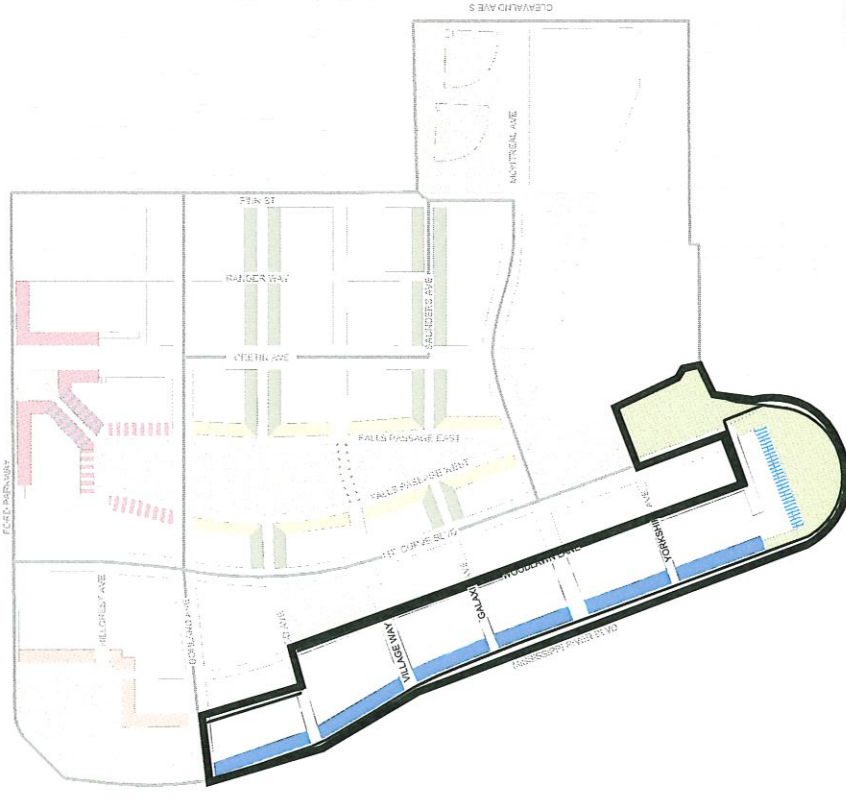

NTS

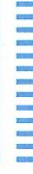
-  Mississippi River Boulevard Frontage
-  Mississippi River Boulevard South Frontage
-  F1 District Boundary

F2 Residential Mixed Low District

The Residential Mixed Low District is intended to have an established residential neighborhood character. The neighborhood park is located in this district which will further reinforce a neighborhood character and scale.

Building types allowed by zoning: carriage house, townhouse, multi-family **low**, live/work, mixed residential/commercial, and commercial/employment.

Building Standards

S6. All residential entrances within fifteen feet (15') of the front property line shall be raised above the average finished grade of the sidewalk a minimum of eighteen inches (18") subject to ADA requirements.

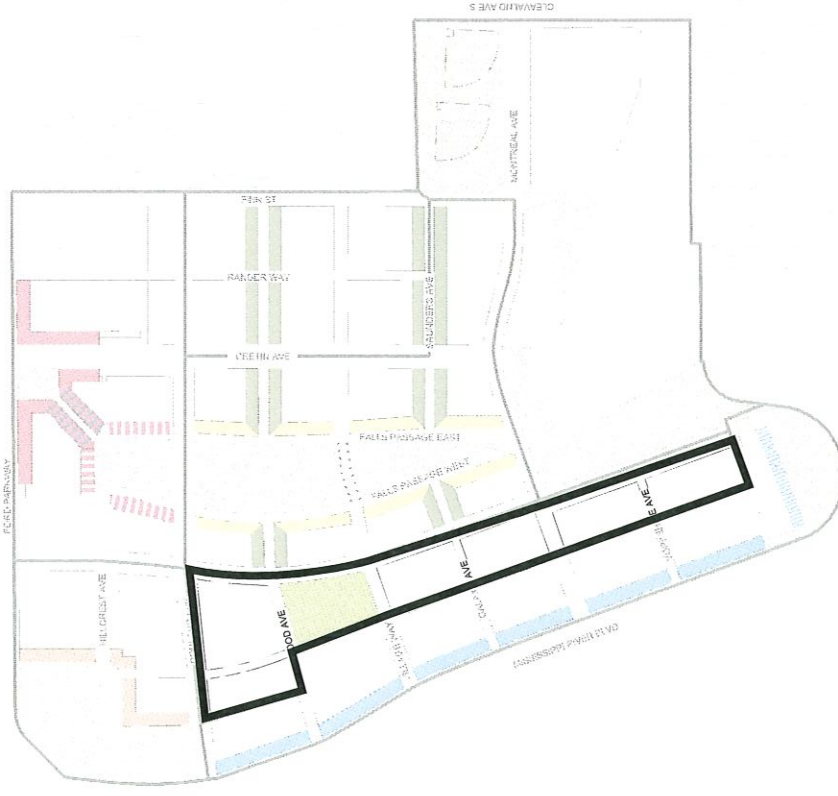

NTS

— F2 District Boundary







F5 Business Mixed District

This district will function as the commercial center of the site. The entrance and identity of the site hinges on the Urban Plaza. The Civic Square will act as the physical 'heart' of the neighborhood and will host a variety of seasonal activities. The diagonal way that connects the two will support a signature pedestrian-oriented destination.

Building types allowed by zoning: **multi-family**, mixed residential & commercial, commercial/employment, civic/institutional and parking structures.



-  Urban Center Frontage
-  Urban Center Diagonal Frontage
-  Urban Center Residential Frontage
-  F5 District Boundary

6.2 Building Types by Zoning District

The zoning districts for the Ford site allow a range of land uses and building types. Some of the zoning standards for the site are specific to the underlying zoning district, as described in Chapter 4, and some are specific to the building type, as described in this chapter. The following table shows the building types that are allowed within each zoning district. Four of the six zoning districts allow a mix of residential and commercial uses. The two more restrictive districts are River Residential, which allows a limited residential form, and Gateway, which allows limited residential uses. Civic and Institutional Uses are allowed in all districts.



Table 6.1 Building Types Allowed by Zoning District

ZONING DISTRICT	BUILDING TYPE										
	Single-family Home	Carriage House	Multi-Unit Home	Townhouse	Multi-Family Low	Multi-Family Medium	Live / Work	Mixed Residential & Commercial	Commercial & Employment	Parking Structure	Civic & Institutional
F1 - River Residential											
F2 - Residential Mixed Low											
F3 - Residential Mixed Mid											
F4 - Residential Mixed High											
F5 - Business Mixed											
F6 - Gateway											

6.3 Building Type Standards

Zoning standards related to each building type are summarized in the table below. These standards are in addition to those related to the underlying zoning district. Subsequent pages address each building type individually, identifying their specific zoning standards and characteristics.

Table 6.2 Building Type Standards Summary Table

STANDARD	BUILDING TYPE										
	Single-Family Home	Multi-Unit Home	Carriage House	Townhouse / Rowhouse	Multi-Family, Low Density <i>Multi-Family</i>	Multi-Family, Medium Density	Live/Work	Mixed Residential & Commercial	Civic & Institutional	Commercial & Employment	Parking Structure
Units per Bldg	1	2-6	1-2	3-16	6-40 6±	40 max	2-8			n/a	
Building Width, maximum		60'		450' 350'	200' n/a	60' min, n/a max	150'			500'	
Lot Width, minimum	60'	80'	Per requirement of primary structure	30' 20'(b)	60' n/a	n/a	30'			n/a	
Lot Coverage by Bldgs, maximum		40%	Included in coverage with primary structure	50%				70% (d)			
Lot Coverage for Open Space, minimum		40%	Included in coverage with primary structure					25%			
Building Height	Determined by Zoning District										
Public Right-of-Way Setback (a), (b)	Determined by Zoning District										
Interior Lot Line Setback	Determined by Zoning District										
Parking	Determined by Zoning District										
Accessory Structures	Determined by Zoning District										

(a) Maximum building setback limit shall apply to at least 60% of the building façade along the right-of-way. Buildings shall be setback a minimum of thirty (30) feet, with no maximum setback, from a lot line separating a lot from Mississippi River Boulevard.

(b) Buildings shall be setback a minimum of thirty (30) feet, with no maximum setback, from a lot line separating a lot from Mississippi River Boulevard.

(c) The minimum lot width figure for townhouses is per unit. Where land under each unit constitutes an individually described lot and all other land required for yards, parking and access constitutes "common" properties jointly owned by the owners of the units, the floor area ratio, lot width, and lot coverage requirements shall be applied to the entire parcel.

(d) No setback is required for building walls containing no windows or other openings when the wall meets the fire resistance standards of the Minnesota State Building Code and there is a Common Interest Community (CIC) or recorded maintenance easement that covers the affected properties.

(e) Portions of an underground parking structure that is above grade due to a slope, where the top serves as an amenity space and is less than eight (8) feet above the adjacent grade, shall be excluded from lot coverage by buildings.



Townhouse / Rowhouse

Dwelling units	3-16 units per building
Lot width, minimum	30 feet <u>20 feet</u>
Building width, maximum	150 feet <u>350 feet</u>
Lot coverage by buildings, maximum	50%
Lot coverage by open space, minimum	25%
Building height	Determined by zoning district
Setbacks	
Front	Minimum 10 feet; maximum 20 feet
Interior Lot Line	Minimum 6 feet, except as noted in Table 5.2 Building Type Standards Summary Table, footnote (c)
Parking requirements	Minimum 0.75 spaces per dwelling unit; maximum 2.0 spaces per dwelling unit; except as noted in Chapter 4, Parking
Accessory buildings allowed	Up to 1 per dwelling unit

Definition: A residential building consisting of three or more dwelling units attached horizontally in a linear arrangement, with each unit having a private entrance and having totally exposed front and rear walls to be used for access, light, and ventilation.

Access: Each unit has independent front and rear egress, and may have private space in the front and/or rear of the unit. If stairs are needed, they will directly connect the sidewalk to the front door.



Multi-Family, Low

Dwelling units	6-40 units per building 6 or more
Lot width, minimum	60 feet n/a
Building width, maximum	200 feet n/a
Lot coverage by buildings, maximum	70%
Lot coverage by open space, minimum	25%
Building height	Determined by zoning district
Setbacks	
Public Right-of-Way	Minimum 10 feet; maximum 20 feet
Interior Lot line	Minimum 6 feet, except as noted in Table 5.2, Building Type Standards Summary Table, footnote (c)
Parking requirements	Minimum .75 spaces per dwelling unit, maximum 2.0 spaces per dwelling unit; except as noted in Chapter 4, Parking
Accessory buildings allowed	Up to 2 per main (principal) building



Definition: A small, to medium-sized building with multiple dwelling units, occupying a portion, but not all of, a city block. The dwelling units may be of mixed sizes (number of bedrooms) and styles to encourage mixed-income development and to meet the needs of families of all sizes. This building type allows for different types of housing arrangements besides single family, such as senior housing or congregate living. The building may include other uses, such as local office and commercial.

Access: Entry to individual units on the ground floor may be shared through one exterior entry, or units may have individual entries along the front facades. **Ground level non-residential units may have individual access on front facades. Upper floor units may be accessed through common exterior entries.** Vehicular access shall be confined to side and rear streets.

Multi-Family, Medium



Dwelling units	40 or more
Lot width, minimum	n/a
Building width, maximum	n/a
Lot coverage by buildings, maximum	70%
Lot coverage by open space, minimum	25%
Building height	Determined by zoning district
Setbacks	
Public Right-of-Way	Minimum 10 feet; maximum 20 feet
Interior Lot Line	Minimum 6 feet, except as noted in Table 5.2, Building Type Standards Summary Table, footnote (c)
Parking requirements	Minimum 0.75 spaces per dwelling unit; maximum 2.0 spaces per dwelling unit; except as noted in Chapter 4, Parking
Accessory buildings allowed	Up to 2 per main (principal) building

Definition: A medium to large building with multiple dwelling units, which may occupy a portion of a city block or a full city block. The building may include other uses, such as local office and commercial. The dwelling units may be of mixed sizes (number of bedrooms) and styles to encourage mixed-income development and to meet the needs of families of all sizes. This building type allows for different types of housing arrangements besides single family, such as senior housing or congregate living.

Access: Units typically share exterior access with one shared entry along the front facade. Ground level non-residential units may have individual access on front facades. Vehicular access shall be confined to side and rear streets.



Woodlawn Avenue (South)

Woodlawn Avenue is a **shared lane** for local travel only to the adjacent blocks and residences, with one side of on-street parking. **There is no demarcation within the 30-foot wide right-of-way to separate cars, pedestrians and bicycles.** All users will share the lane and travel speeds will be very low. **Since pedestrians and bicyclists are intended to use the lane for travel, there is no adjacent boulevard or sidewalk space.** A private setback for vegetation and driveways will separate buildings from the roadway.

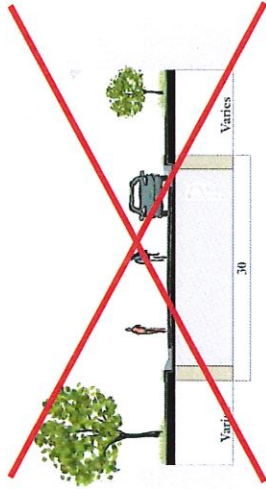

TOTAL RIGHT-OF-WAY	30
CURB TO CURB DISTANCE	28
BOULEVARD TRANSITION (feet per side)	1
VEHICULAR	Shared
BIKE	
PEDESTRIAN	
ON-STREET PARKING	
TOTAL RIGHT-OF-WAY	30
CURB TO CURB DISTANCE	22
VEHICULAR	Shared
BIKE	
BOULEVARD TRANSITION (feet per side)	4
PEDESTRIAN/ EASEMENT	10
ON-STREET PARKING	8

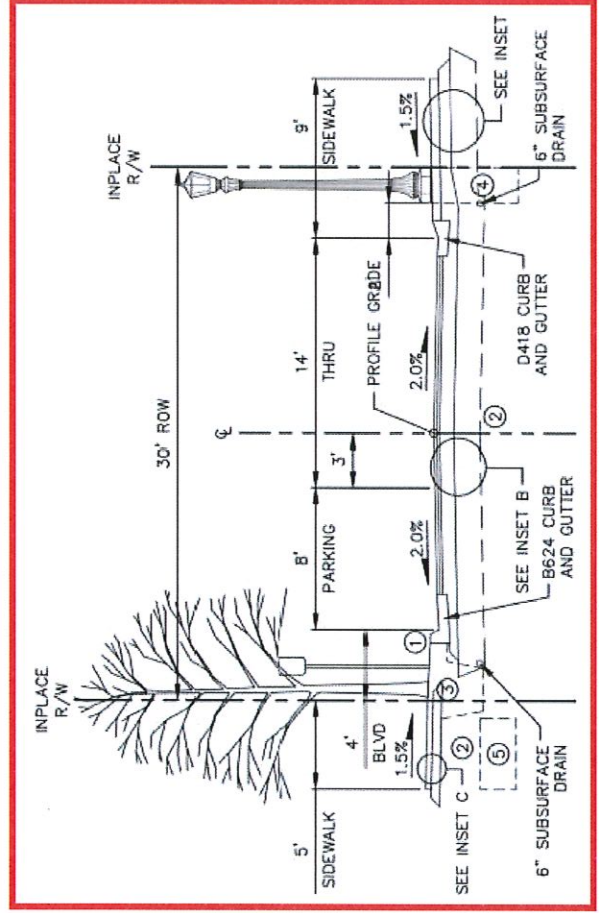



January 31, 2020



Menaka Mohan
Ford Site Planner
City of Saint Paul
25 W. 4th Street, Suite 1400
Saint Paul, MN 55102

RE: Ford Site Zoning and Public Realm Master Plan

Dear Ms. Mohan:

Ryan Companies US, Inc. (Ryan) is submitting an application for proposed amendments to the Ford Site Zoning and Public Realm Master Plan (Master Plan), adopted by the St. Paul City Council on 9/11/19, and the corresponding Zoning Code Text. The intent of the amendments is to clean up inconsistencies and update parameters realized after the adoption of design standards, the initial infrastructure design, and the completion of the Redevelopment Agreement and associated agreements.

Included in this submittal is the following information:

- **Master Plan and Zoning Code Amendment Application Forms** – we are applying for amendments to the approved Master Plan under Zoning Code Section 66.951 and amendments to the existing Zoning Code under Zoning Code Section 61.801.
- **Ryan Companies Executive Summary** – a summary of the areas that we are proposing to amend in the Master Plan. Each section includes background along with justification as to why each of the proposed amendments should be approved.
- **Ryan Companies Amendment List** – an Excel spreadsheet that lists each proposed amendment, where it is found in the Master Plan, how that amendment affects the City of St. Paul zoning code/text/map, and the justification linked to each proposed amendment.

Please note that there is some urgency to approving the Supportive Housing land use within the F6 Zoning District as well as the allowance of Multi-Family Medium in the F5 district in order to deliver the affordable housing projects as described in the obligations of the Redevelopment Agreement. Our affordable partners require these amendments in order to make applications to agencies for project support and to adhere to other contractual obligations. We have included interim use applications for those two specific uses with this masterplan amendment submittal.

Ryan Companies US, Inc.
533 South Third Street, Suite 100
Minneapolis, MN 55415

p: 612-492-4000
ryancompanies.com

Equal Opportunity Employer



Please reach out if there are any questions or clarification with the documents.

Sincerely,

A handwritten signature in green ink that reads "Tony Barranco". The signature is written in a cursive style with a long horizontal stroke above the first name.

Tony Barranco
Senior Vice President, Real Estate Development
Ryan Companies US, Inc.



MASTER PLAN AMENDMENT APPLICATION

Department of Planning and Economic Development
Zoning Section
1400 City Hall Annex, 25 West Fourth Street
Saint Paul, MN 55102-1634
(651) 266-6583

Zoning Office Use Only
File # _____
Fee Paid \$ _____
Received By / Date _____
Tentative Hearing Date _____

APPLICANT

Name Project Paul, LLC (Ryan) & MN Ford Site Apartment Land, LLC (Weidner) Email tony.barranco@ryancompanies.com
(must have ownership or leasehold interest in the property, contingent included)
Address 533 S Third St, Suite 100 City Minneapolis State MN Zip 55415
Email tony.barranco@ryancompanies.com Phone 612-492-4000
Name of Owner (if different) Tony Barranco Email tony.barranco@ryancompanies.com
Contact Person (if different) Tony Barranco Email tony.barranco@ryancompanies.com
Address 533 S Third St, Suite 100 City Minneapolis State MN Zip 55415

PROPERTY INFO

Address/Location 2192 Ford Pkwy St. Paul, MN 55116
PIN(s) & Legal Description 172823130002
(attach additional sheet if necessary)
See attached sheet with Legal Descriptions of the Ryan & Weidner owned properties Lot Area 121.73 Current Zoning F1-F6

REQUEST: Application is hereby made to modify or amend an adopted Master Plan under provisions of Zoning Code § 66.344(c) or § 66.951.
Proposed Amendment Amendments to the Ford Site Zoning and Public Realm Master Plan
(attach additional sheets if necessary)

SUPPORTING INFORMATION: State what the Master Plan calls for, what amendment is proposed, and the reason for the amendment. Attach additional sheets if necessary.

See attached Executive Summary

Required site plan is attached.
 If you are a religious institution you may have certain rights under RLUIPA. Please check this box if you identify as a religious institution.

Applicant's Signature Date 1/24/2020
Tony Barranco 1/28/2020 Rev 8.5.2019



ZONING CODE AMENDMENT APPLICATION

Department of Planning and Economic Development
Zoning Section
1400 City Hall Annex, 25 West Fourth Street
Saint Paul, MN 55102-1634
(651) 266-6583

Zoning Office Use Only
File # _____
Fee Paid \$ _____
Received By / Date _____
Tentative Hearing Date _____

APPLICANT

Property Owner(s) Project Paul, LLC (Ryan) & MN Ford Site Apartment Land, LLC (Weidner)
Address 533 S Third St, Suite 100 City Minneapolis State MN Zip 55415
Email tony.barranco@ryancompanies.com Phone 612-492-4000
Contact Person (if different) Tony Barranco Email tony.barranco@ryancompanies.com
Address 533 S Third St, Suite 100 City Minneapolis State MN Zip 55415
(Attach additional sheet if necessary to include all of the owners of at least 67% of the property affected by the amendment.)

PROPERTY INFO

Address/Location 2192 Ford Pkwy St. Paul, MN 55116
PIN(s) & Legal Description 172823130002
(Attach additional sheet if necessary.)
See attached sheet with Legal Descriptions of the Ryan & Weidner owned properties
Lot Area 121.73 Current Zoning F1-F6

TO THE HONORABLE MAYOR AND CITY COUNCIL:

Pursuant to Saint Paul Zoning Code § 61.801 and Minnesota Statutes § 462.357, Project Paul, LLC (Ryan) and MN Ford Site Apartment Land, LLC (Weidner)

owner(s) of at least 67% of the land in the F1-F6 zoning district(s), hereby petition(s) to amend provisions in the Zoning Code pertaining to the F1-F6 zoning district(s) as follows:

See attached Executive Summary

Attach additional sheets if necessary. Attachments as required: Site Plan

If you are a religious institution you may have certain rights under RLUIPA. Please check this box if you identify as a religious institution.

Subscribed and sworn to before me

Date January 28 2020
Michelle Felt
Notary Public



By: Tony Ba
Fee owner of property
Title: SVP

Subscribed and sworn to before me

Date JANUARY 28 2020
Linda A Dammer
Notary Public

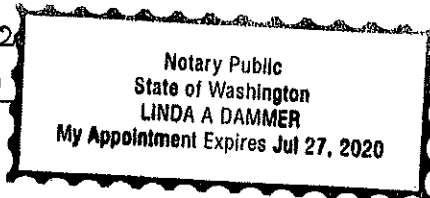

By: Calvin Weidner
Fee owner of property
Title: Manager and Sole Member

Request for Continuance

Date 2/4/20

Dan Edgerton, Chair
Zoning Committee
City of Saint Paul
1400 City Hall Annex
Saint Paul, MN 55102

Re: Zoning File #20-009995 (Zoning Text Amendments) and #20-010013 (Master Plan Amendments)

Dear Mr. Edgerton:

I am the applicant or the applicant's duly appointed representative for this zoning file.

I request a continuance of the public hearing on the application in this zoning file, which is presently scheduled before the Zoning Committee on February 27, 2020.

I understand that a continuance of the public hearing before the Zoning Committee means that the decision of the Planning Commission on this application, which is presently scheduled for March 6, 2020 will also be continued.

I request that the Zoning Committee continue the public hearing for this zoning file to March 12, 2020, I understand that the Planning Commission would then be scheduled to make their decision on March 20, 2020.

I am aware of and understand the statutory requirements found in Minn. Statue § 15.99 (1995) requiring the City of Saint Paul to approve or deny this application within sixty days of its submission. I desire to extend the sixty-day period for a City decision under Minn. Stat. §15.99 by 14 days to accommodate the continuance I am requesting.

Sincerely,

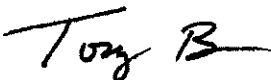

Signature of applicant or
applicant's duly appointed
representative



Printed name of applicant or
applicant's duly appointed
representative

Updated: 10/13/2017



Ford Site Zoning and Public Realm Master Plan Ryan Companies Executive Summary 02.05.2020

The following is an Executive Summary of the proposed changes to the Ford Site Zoning and Public Realm Master Plan. While the overall land uses, zoning districts, and densities remain consistent from the approved Master Plan, these amendments are necessitated in order to align design standards, adjust zoning districts to match platted streets, clean up inconsistencies, and to update certain parameters that have been realized after initial infrastructure design and the completion of the Redevelopment Agreement. This Summary should be used in alliance with the *Ryan Companies Amendments List* for a comprehensive assessment.

Ryan is requesting interim use approval for Supportive Housing in the F6 zoning district and Multi-Family Medium in the F5 zoning district as soon as possible. These uses are further explained in section 2(b) and 2(c) below.

The following categories provide an overview of the proposed changes to the Ford Site Zoning and Public Realm Master Plan:

1. Townhouses

As Ryan has continued to work with potential development partners for the rowhome portion of the redevelopment, it has become apparent that a number of parameters within the Master Plan are not conducive to the market standards of rowhomes within the region. The requested amendments outlined below will help to provide variable price options for the townhomes.

a. **Addition of Townhouses to the allowable building types in the F1 zoning district.**

- i. The F1 zoned blocks that line the western edge of the development have continuously been shown in the Ryan Development Plan to include rowhomes on the eastern edge of those blocks. The 1-6 unit homes are proposed directly adjacent to Mississippi River Boulevard and the rowhomes proposed adjacent to Woodlawn Avenue with a private alley separating the two. While the Ryan plan remains the same as it has been, there was an oversight not to allow for this use within the F1 district.

b. **Adjustments to the Townhouse minimum lot width from 30' to 20'.**

- i. Ryan has heard a desire from our potential rowhome partners to provide units as small as 20' in width. The preferred method of developing rowhomes is to sell them as Fee Simple, meaning the owner of the individual rowhome unit would own the land directly underneath their property, which would position the property line at the center of the shared wall between two units. With a 20' wide unit sold as Fee Simple, this

would force the minimum lot width to be 20' as well. The 20' minimum width is consistent with some of the existing city zoning code from the RT2 zoning district and the smaller units will provide a lower priced option for this housing type, so Ryan views it as a beneficial change.

c. Adjustments to the Townhouse maximum building width from 150' to 350'.

- i. As design of the rowhome blocks has progressed it has become apparent that if the rowhome structures are separated into smaller buildings ranging from 4-6 units, hidden corners are created between each of the buildings which could create a safety concern. It also allows for sightlines between the buildings into the back alleys of the rowhomes. From a safety and aesthetic standpoint these are less desirable. We feel that a continuous building façade helps to better define the street edge and direct pedestrian traffic where it should actually be focused: within the right of way and not in back alleys. Considering the minimum lot width adjustment above, a maximum of 16' units (max number of units per the current Master Plan) would still be able to fit within the 350' revised maximum building width. Note: the previous Master Plan numbers did not add up when you compare the allowable units per building and the maximum building width, but this change would allow the maximum number of 16 units.

d. Adjustments to the Townhouse maximum lot coverage by buildings from 50% to 60%.

- i. As mentioned above there is a strong desire to be able to sell the rowhome properties as Fee Simple. With that property condition and the proposed size of a typical unit, the maximum lot coverage by building would exceed 50%. 60% is an appropriate number to allow a common unit depth of building (typically 40-45' deep).

e. Adjustments to the Townhouse minimum setbacks, for properties only adjacent to the shared bike/ped paths, from 10' to 4'.

- i. The minimum setback from any public right of way for a rowhome building is 10'. This means that for a normal city street (one with sidewalks against the property line) there is a 10' setback between the path of travel and the closest structure. For the shared bike/ped paths, the path of travel is pushed further away from the buildings to the point there is a 16'-20' setback between the path of travel and the closest structure, depending on the right of way section considered. The right of way section varies for Beechwood (40') and both Saunders and Yorkshire (32'). We would like to propose a 4' setback for any rowhome structure adjacent to a bike/ped shared path in order to provide a 10' setback as is elsewhere within the site. Note that most everywhere else within the site there is a minimum 5' setback from the path of travel in the public right of way. We feel this adjustment will better hold the street edge on these ped/bike streets and will prevent an awkward side yard condition whereby

it is unclear where the right of way and where the private property intersect.

2. Affordable Housing

As Ryan has continued to work with our affordable housing partners to achieve the affordable housing requirements set forth within the Master Plan and to spread those projects throughout the Ford Site, some Master Plan adjustments are necessary to accommodate zoning of the affordable housing projects. The locations were not yet established at the time of the 2018 Master Plan submittal, but the redevelopment agreement approved the locations of the affordable housing parcels per what the Ryan Development Plan currently shows.

a. Adjustment to allow Multi-Family Medium building types in the F2 zoning district

- i. An affordable project is designated for the north side of Block 9 in order to provide a number of affordable housing units in the southwest quadrant of the site (south of Bohland Ave and west of the Central Water Feature). A higher number of affordable units can be provided with a slightly denser building than what the current zoning allows. Multi-Family Low buildings are allowed in the F2 district but is limited to between 6-40 units per building. The anticipated affordable project located on Block 9 will provide approximately 60 units (over 3 floors) which triggers the Multi-Family Medium designation. Please note that the FAR and height restrictions of the F2 zone will remain as they are in the Master Plan so the massing of the building will still blend with the surrounding building types.

b. Adjustment to allow Multi-Family Medium building types in the F5 zoning district

- i. Ryan has entered into an agreement with CommonBond Communities to develop affordable housing within Lot 2, Block 3 of the Ford Site. CommonBond intends to develop an affordable housing project focused on low income Seniors. The building is expected to be approximately 53 units with a heavy mix of 30% AMI and some 50% AMI renters. While the location of the project is within the F5 Mixed-Use zoning district, CommonBond intends the project to be Multi-Family Medium designation only (no commercial component) which is currently not allowed within the F5 zoning district. This location is an ideal location for Seniors, especially due to its close proximity to area amenities including grocery, retail, and medical services. This proposed development is in alignment with the affordable housing plan and provisions contained in the City and Ryan Redevelopment Agreement. There is also a deed restriction already recorded on the property that obligates that an affordable project of this size be delivered on the site.

c. Adjustment to allow Supportive Housing in the F6 zoning district.

- i. Ryan has entered into an agreement with Project for Pride in Living (PPL) to develop affordable housing on a to be formed parcel that is a portion of Lot 1, Block 1 of the Ford Site. PPL intends to develop two projects: one building for workforce affordable housing and the other for affordable housing with supportive services. The workforce housing project will be slightly larger in size, currently estimated at approximately 80 units, and will be developed with a mix of 50% AMI and 60% AMI units. The supportive housing will be slightly smaller, approximately 60 units, most at 30% AMI, and will provide a safe housing environment for women, children, and families who have experienced trauma and require a safe, secure place to live. Supportive services will be provided within the supportive housing building and will actually be a relocation of one of the operator's existing facilities. Both buildings are intended to share underground parking between the two buildings. While the Multi-Family Medium designation of the workforce housing project is allowed in the F6 zoning district, supportive housing is currently not an allowed use within the F6 zoning district. This proposed development is in alignment with the affordable housing plan and provisions contained in the City and Ryan Redevelopment Agreement. There is also a deed restriction already recorded on the property that obligates that an affordable project of this size be delivered on the site.

3. Land Uses

Ryan has continued to market the site to potential tenants throughout the due diligence and acquisition phases of the redevelopment. We have also continued to check our development plan against the development ranges allowed within the Master Plan and have some adjustments to propose in order to better align with the market feedback we are receiving from potential tenants.

a. Adjustment to the minimum commercial in the F6 zoning district to 0%

- i. There is currently a minimum commercial requirement within the F6 zoning district. Due to the locations of the F6 district and the distance away from the commercial hub of Ford Pkwy and Cleveland Ave, we believe the land uses within the F6 zoning district are better served as non-commercial uses. We are intending to centralize as much of the commercial uses in the F5 district to create a retail hub instead of remote retail locations, which will be essential for those retail businesses to survive.

b. Adjustment to allow Religious Institution, Place of Worship in the F1 zoning district.

- i. Ryan intends to design, construct, and donate a number of structures throughout the Ford Site parcel over a few years to further enhance the public realm within the Ford Site. One of those structures. Ryan sees a

unique opportunity to locate a small chapel on the southern end of the site on Lot 1, Block 35, which is in the F1 zoning district. The location would be in the southeast corner of that lot adjacent to the public park space.

4. Building Type Requirements

As the infrastructure design has progressed, Ryan has been further evolving the proposed concepts for the mixed-use and multi-family residential type projects, specifically how the underground structured parking ties out with the surrounding grades, in the north and eastern portions of the site. Due to the elevation changes across each development block and how the City interprets some of their zoning regulations, we will require some adjustments in order to successfully produce the intended development types.

a. Adjustment to the Maximum Lot Coverage By Buildings allowed from 70% to 95% for all applicable building types listed in Table 6.2

- i. For many of the mixed-use and multi-family residential buildings proposed throughout the site, it is Ryan's intent to construct 4-6 story residential "bar" shaped corridors in the shapes of typical residential buildings ("H" shaped, "U" shaped, etc.). These residential buildings would be constructed over top of underground structured parking which encompasses most of each parcel area to maximize efficiency of the structured parking. Due to the elevation change across the site, portions of the structured parking would then be partially exposed to the surface. The City typically calculates the building lot coverage as any structure that is above grade, which is especially challenging when trying to incorporate underground structured parking on a sloped site. Therefore, we are requesting an increase in the maximum building lot coverage in order to allow for the structured parking similar to how we have the buildings drawn up in the Ryan Development Plan. Note: The residential "bar" portions of the building would still be a lesser building coverage on the lot.

b. Adjustment to allow all usable rooftop space to count towards the Minimum Lot Coverage For Open Space.

- i. For many of the mixed-use and multi-family residential buildings proposed throughout the site, it is Ryan's intent to provide rooftop amenities that are located on top of the structured parking. These will typically be at the first or second level of a building depending on the calculation for the finished floor elevation over the sloped site. There is a current requirement in the Master Plan that allows green roofs or roof amenities to count towards the minimum open space calculation, but only if it is above the third floor. We feel that this should be allowed for any elevation above the ground, not just at the third floor or above, and actually helps the rooftop amenity to feel like true open space throughout the rest of the Ford Site if it's allowed at any floor elevation.

5. Roadways

As infrastructure design has progressed it has become apparent that the shared lane of Woodlawn Ave is considered to function more like a street than a shared lane if it contains street parking. Ryan has worked with City planning, public works, and fire safety staff to reach an agreement on an adequate street section in order to meet the traffic and safety concerns for the street section.

a. Adjustment to the Woodlawn Ave roadway section.

- i. In order to provide adequate pedestrian safety, public sidewalks have been added on either side of the street section to remove the pedestrian and vehicle conflicts. Easements are required and have been added in as part of the approved FORD plat to the adjacent properties in order to accommodate the sidewalks. There is additional sidewalk provided on the opposite side of the street from the parking lane in order to provide adequate space for fire trucks to service during an emergency. See included street section exhibit for the proposed street section change.

6. Signage

There will be a mix of uses within the Ford Site including retail, office, medical, and various types of residential buildings. Each of those uses will require different signage within their site.

a. Addition of F Districts to Section 64.502 of the Zoning Code.

- i. The allowances within Section 64.502 of the Zoning Code are better suited for the F Districts than the current allowed signage and will provide more site-appropriate signage for each of those specific uses.



Ford Site Zoning and Public Realm Master Plan - Ryan Companies Amendments List 02.05.2020

Change	Requested Change to Ford Zoning and Public Realm Master Plan	Page #	Corresponding Change to Zoning Code Text or Map	Section #	Justification for Request *Refer to Executive Summary Document*
1	Addition of Townhouses to the allowable building types in the F1 zoning district	31, 34, 72, 92	Adding Townhomes to Section 66.912, Adjustment to Table 66.931	66.912, 66.931	Refer to #1 Townhouses section
2	Adjustment to the Townhouse minimum lot width from 30' to 20'	93, 97	Adjustment to Table 66.931	66.931	Refer to #1 Townhouses section
3	Adjustment to the Townhouse maximum building width from 150' to 350'	93, 97	Adjustment to Table 66.931	66.931	Refer to #1 Townhouses section
4	Adjustment to the Townhouse maximum lot coverage by buildings from 50% to 60%	93, 97	Adjustment to Table 66.931	66.931	Refer to #1 Townhouses section
5	Adjustments to the Townhouse minimum setbacks, for properties only adjacent to the shared bike/ped paths, from 10' to 4'.	93, 97	Adjustment to Table 66.931	66.931	Refer to #1 Townhouses section
6	Adjustment to allow Multi-Family Medium building types in the F2 zoning district	75, 92	Adding Multi-Family Medium to Section 66.913, Adjustment to Table 66.931	66.913, 66.931	Refer to #2 Affordable Housing section
7	Adjustment to allow Multi-Family Medium building types in the F5 zoning district	80, 92	Adding Multi-Family Medium to Section 66.916, Adjustment to Table 66.931	66.916, 66.931	Refer to #2 Affordable Housing section
8	Adjustment to allow Supportive Housing in the F6 zoning district.	42, 84	Adjustment to Table 66.921	66.921	Refer to #2 Affordable Housing section
9	Adjustment to the minimum commercial in the F6 zoning district to 0%	40	-	-	Refer to #3 Land Uses section
10	Adjustment to allow Religious Institution, Place of Worship in the F1 zoning district	42	Adjustment to Table 66.921	66.921	Refer to #3 Land Uses section
11	Adjustment to the Maximum Lot Coverage By Buildings allowed from 70% to 95% for all applicable building types listed in Table 6.2	93, 98-104	Adjustment to Table 66.931	66.931	Refer to #4 Building Type Requirements section
12	Adjustment to allow all usable rooftop space to count towards the Minimum Lot Coverage For Open Space.	57	-	-	Refer to #4 Building Type Requirements section
13	Adjustments to the Woodlawn Ave roadway section	120	-	-	Refer to #5 Roadways section
14	-	-	Addition of F Districts to Section 64.502 of the Zoning Code	64.502	Refer to #6 Signage section

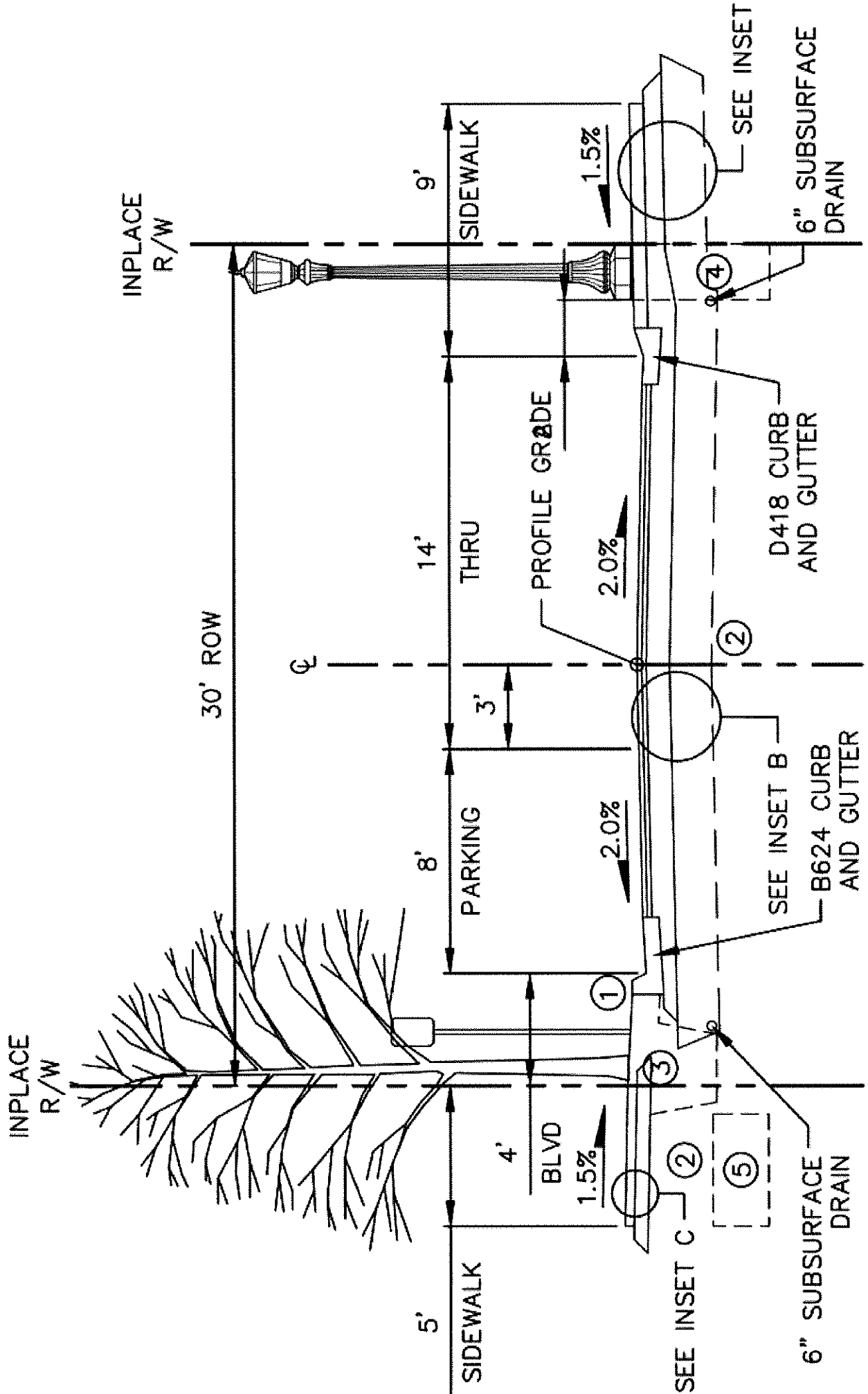

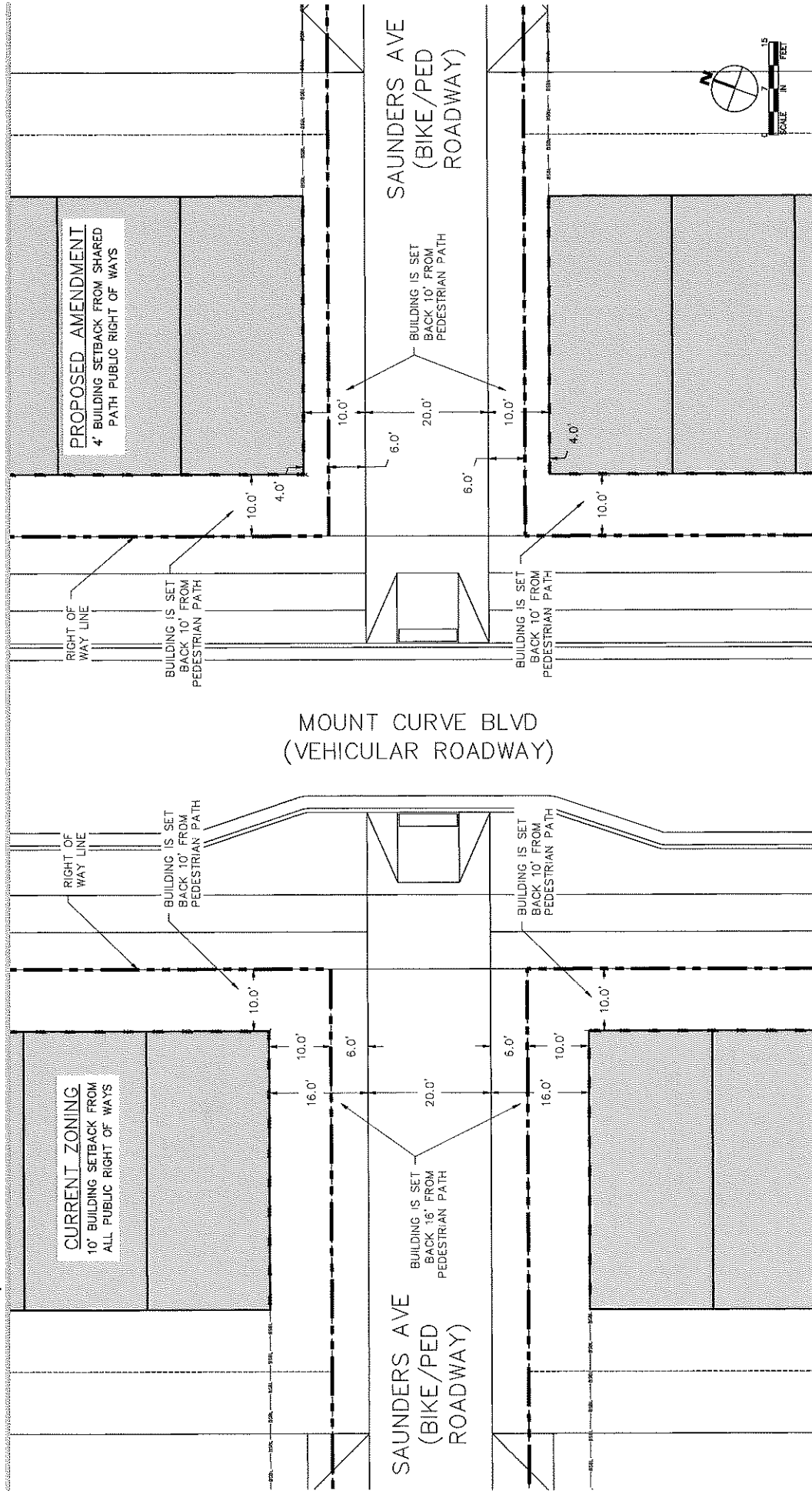

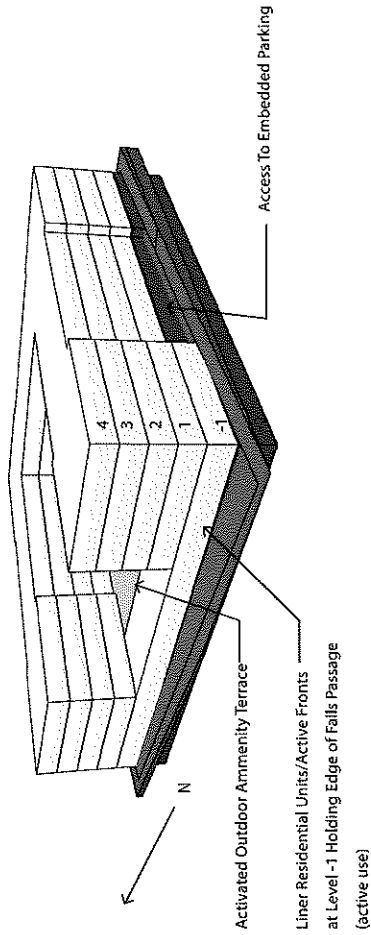

Perspective Looking SW

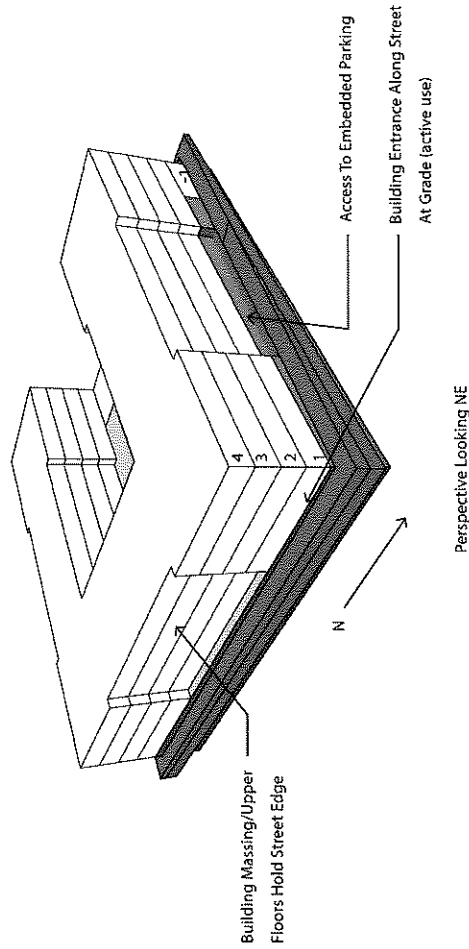

Perspective Looking NE

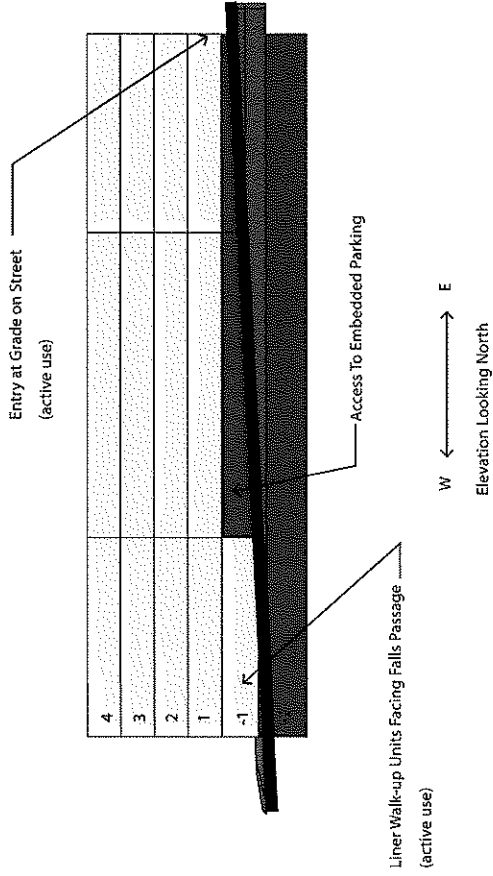

- Multi-story residential designed to hold street edges and corners of the site to frame the public ROW and maximize active use as much as possible.
- Typical grade change across the F3 and F4 districts east of the Central Water Feature is approximately 10-12' east to west.
- Liner residential units placed to hold the edge of the site while hiding the structured parking.
- City code calculations would count the podium cap towards the lot coverage, where on a flat site this would not be counted.

Tyler Beckman

1034 Cleveland Ave S #206, St Paul, MN 55116

Email received on 2/19/2020 from Councilmember Tolbert's office; Email from Tyler Beckman to Menaka Mohan on 2/27/2020 confirmed that the comment should be included in the record.

Chris/Melanie

Just saw this and if it's true that it's moving forward, I'm pretty concerned. We already lost a ton of retail space from what the master plan called for originally in the great compromise, but concentrating what is left on Ford Parkway pretty clearly goes against the spirit of what this whole thing was supposed to be about in the first place - an urban walkable village that is itself a destination, not just a place to live.

Lack of retail throughout the site will create major dead zones in the Ford Site, which will make the area unsafe and unwalkable. I hope you'll oppose this.

One major reason I decided to buy a condo where I did on Cleveland was the hope that one day we might be able to walk to some retail closer to the southern end of the site. If that promise is revoked and it's all on Ford, that's a huge change that would affect a lot more people than just those living on the site.



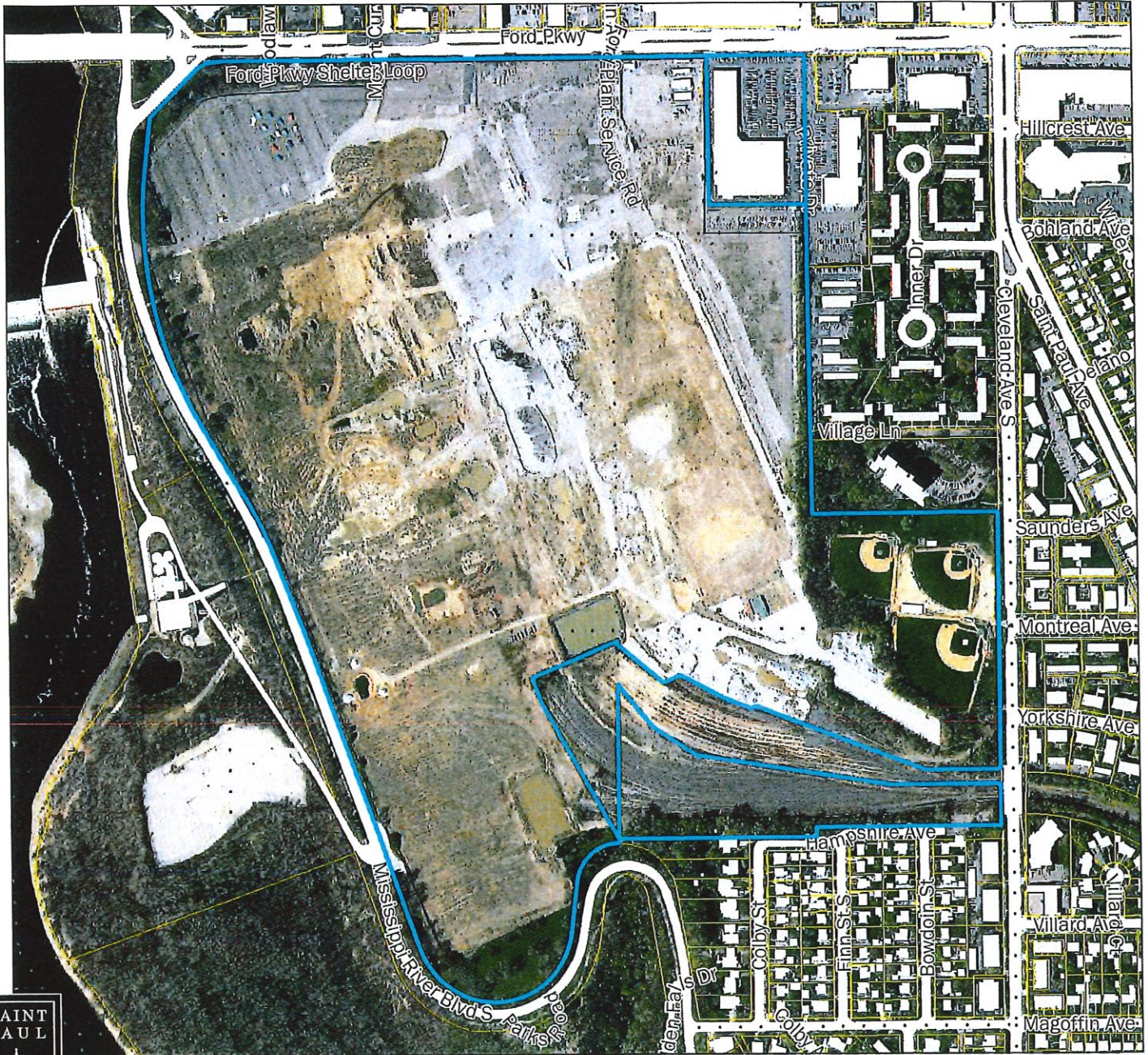

FILE #20-009995 | AERIAL MAP
Ford Districts Zoning Amendments

Application Type: Rezoning
 Application Date: January 31, 2020
 Planning District: 15

Subject Parcel(s) Outlined in Blue

ParcelPoly Yellow

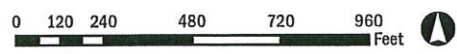

This document was prepared by the Saint Paul Planning and Economic Development Department and is intended to be used for reference and illustrative purposes only. This drawing is not a legally recorded plan, survey, official tax map or engineering schematic and is not intended to be used as such. Data sources: City of Saint Paul, Ramsey County, Metropolitan Council, State of Minnesota.

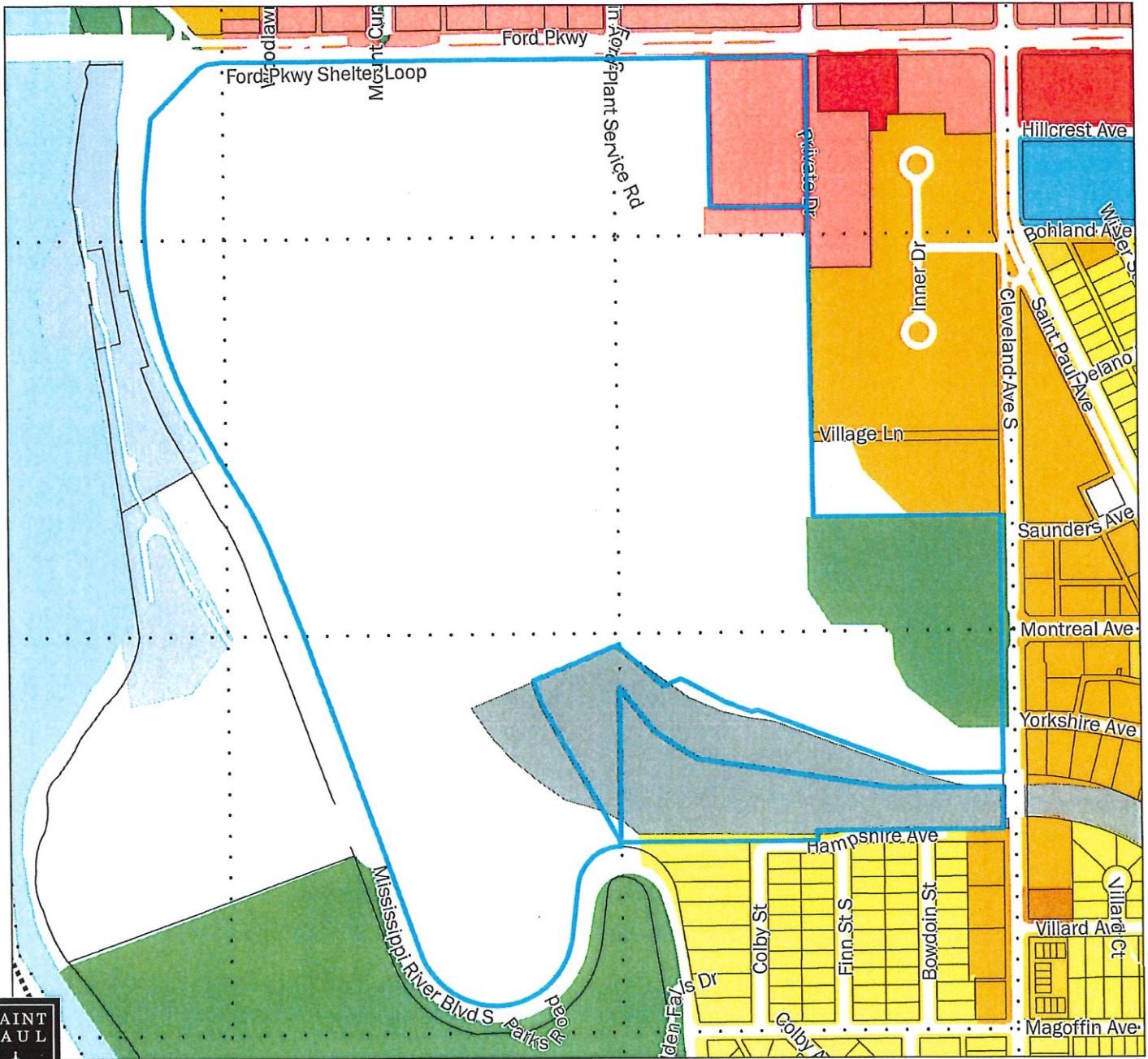

FILE #20-009995 | EXISTING LANDUSE
Ford Districts Zoning Amendments

Application Type: Rezoning
 Application Date: January 31, 2020
 Planning District: 15

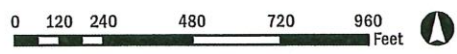

This document was prepared by the Saint Paul Planning and Economic Development Department and is intended to be used for reference and illustrative purposes only. This drawing is not a legally recorded plan, survey, official tax map or engineering schematic and is not intended to be used as such. Data sources: City of Saint Paul, Ramsey County, Metropolitan Council, State of Minnesota.

Subject Parcel(s) Outlined in Blue

- | | | | |
|---------------------------|--------------------------------|--------------------------------|--------------|
| Farmstead | Office | Extractive | Airport |
| Seasonal/Vacation | Retail and Other Commercial | Institutional | Agricultural |
| Single Family Detached | Mixed Use Residential | Park, Recreational or Preserve | Undeveloped |
| Manufactured Housing Park | Mixed Use Industrial | Golf Course | Water |
| Single Family Attached | Mixed Use Commercial and Other | Major Highway | |
| Multifamily | Industrial and Utility | Railway | |

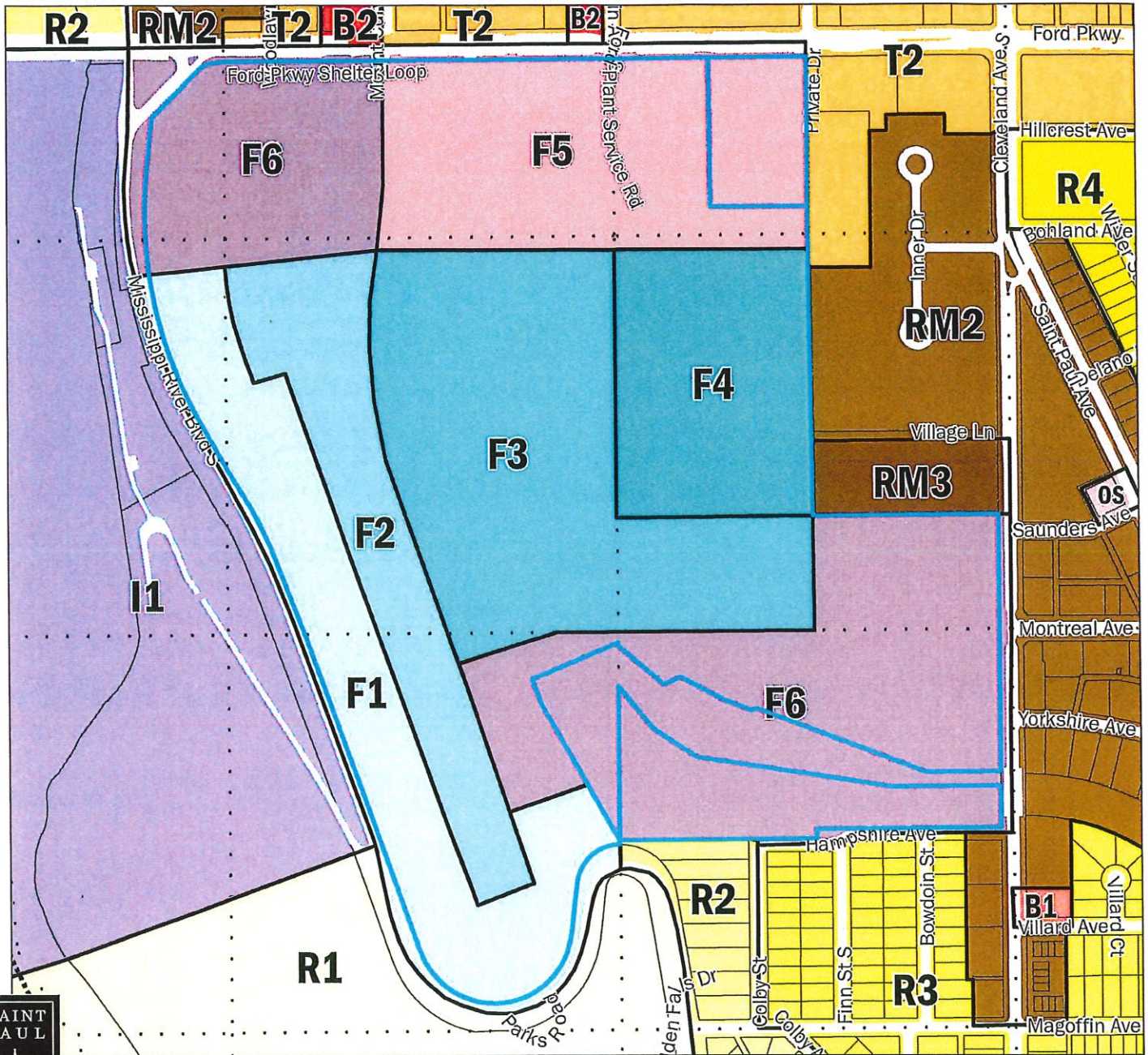

FILE #20-009995 | ZONING MAP
Ford Districts Zoning Amendments

Application Type: Rezoning
 Application Date: January 31, 2020
 Planning District: 15



This document was prepared by the Saint Paul Planning and Economic Development Department and is intended to be used for reference and illustrative purposes only. This drawing is not a legally recorded plan, survey, official tax map or engineering schematic and is not intended to be used as such. Data sources: City of Saint Paul, Ramsey County, Metropolitan Council, State of Minnesota.

Subject Parcel(s) Outlined in Blue

RL One-Family Large Lot	RM3 Multiple-Family	BC Community Business (converted)	I3 Restricted Industrial
R1 One-Family	T1 Traditional Neighborhood	B2 Community Business	F1 River Residential
R2 One-Family	T2 Traditional Neighborhood	B3 General Business	F2 Residential Low
R3 One-Family	T3 Traditional Neighborhood	B4 Central Business	F3 Residential Mid
R4 One-Family	T3M T3 with Master Plan	B5 Central Business Service	F4 Residential High
RT1 Two-Family	T4 Traditional Neighborhood	IT Transitional Industrial	F5 Business
RT2 Townhouse	T4M T4 with Master Plan	ITM IT with Master Plan	F6 Gateway
RM1 Multiple-Family	OS Office-Service	I1 Light Industrial	VP Vehicular Parking
RM2 Multiple-Family	B1 Local Business	I2 General Industrial	PD Planned Development
			CA Capitol Area Jurisdiction



Current Ford Site Zoning

January 30th, 2020

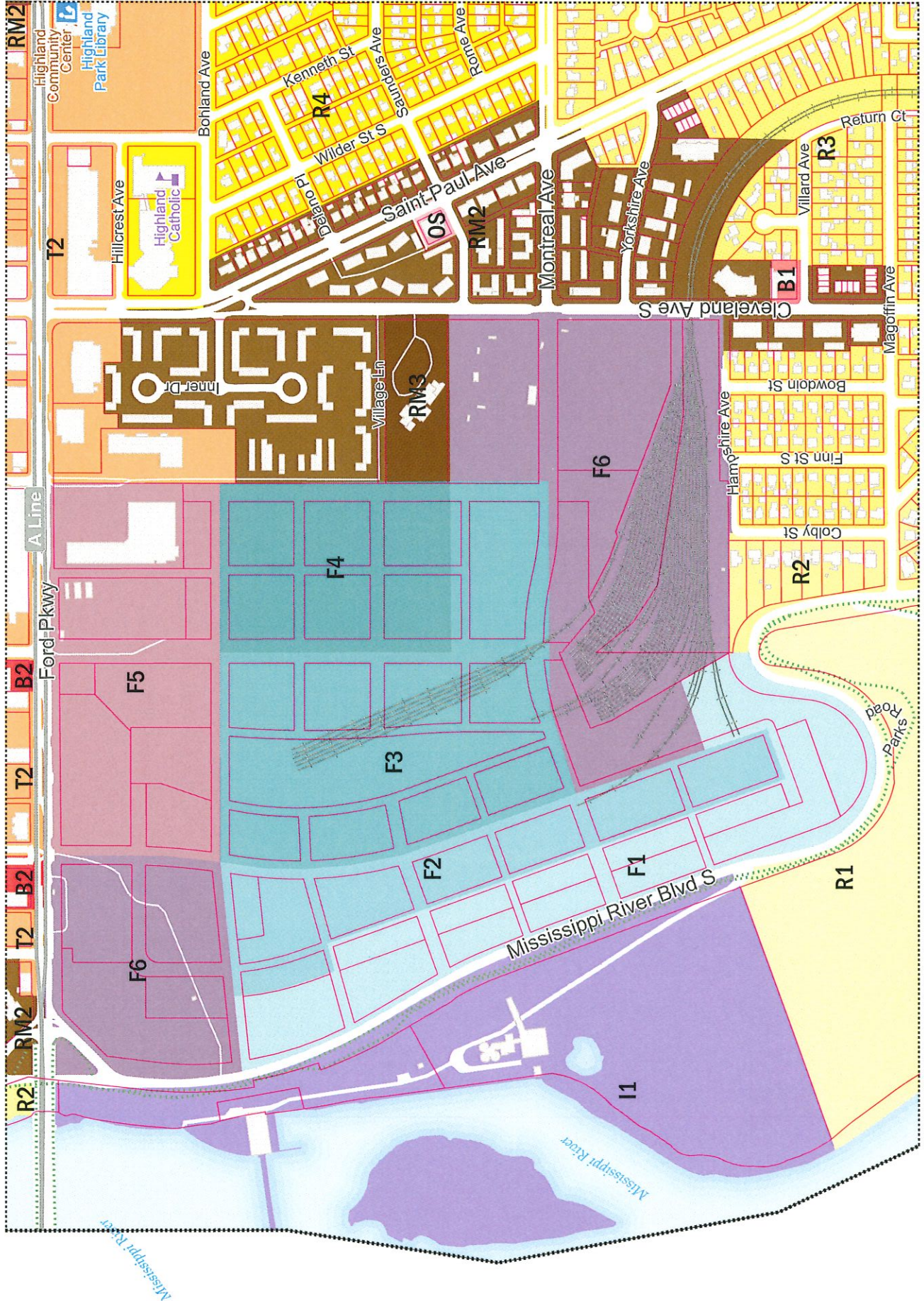

This document was prepared by the Saint Paul Planning and Economic Development Department and is intended to be used for reference and illustrative purposes only. This document is not a legally recorded plan. It may contain errors, omissions, and inaccuracies and is not intended to be used as such. Date Author: St. Paul Enterprise GIS, 5/2/20.